

FLOW METER INSTALLATION EFFECTS

Eric Kelner, P.E.

Southwest Research Institute
6220 Culebra Road
San Antonio, Texas 78238

INTRODUCTION

Meter station piping installation configuration is one of a number of effects that may adversely impact meter accuracy. Some piping configurations can distort the flow stream and produce flow measurement bias errors (i.e., offsets in the meter output) of up to several percent of reading. Valves, elbows, or tees placed upstream of a flow meter are just some of the piping elements that can distort the flow stream. In this paper, installation effects are discussed with respect to two of the four main components of a flow measurement system: the meter, or primary element, and the secondary (pressure and temperature) instrumentation. The effect of the velocity profile of the flow stream on orifice, ultrasonic, and turbine flow meters is discussed next. Installation conditions that may adversely impact the accuracy of pressure and temperature measurements are discussed after that. The gas chromatograph and the flow computer, the third and fourth components, are treated in separate courses.

VELOCITY PROFILE EFFECTS

Typically, one or more measured quantities (such as the pressure differential created across an orifice, the number of rotations produced by a turbine rotor, or the amount of time it takes for a pulse of ultrasonic energy to traverse the flow stream) are used, along with a flow equation, to determine the flow rate. These equations typically assume an “ideal” flow stream at the meter. Usually, the “ideal” flow stream is a fully-developed, symmetric, swirl-free turbulent flow profile.

This “ideal” flowing condition is depicted as a velocity profile in Figure 1. The velocity profile describes the change in velocity along the cross-section of the pipe at a given axial location. At the pipe wall, the velocity of the fluid is zero (a.k.a., the “no-slip” condition). The maximum fluid velocity is at the axial centerline of the pipe. The shape of the velocity profile very near the pipe wall is determined by the viscosity of the fluid, the pipe wall roughness, and the Reynolds number (i.e., the ratio of inertial to viscous forces). A fully-developed turbulent velocity profile is symmetric about the pipe centerline.

A less than ideal velocity profile is one that is distorted in some way. For example, the flow just downstream of a 90° elbow will cause a fully-developed, symmetric, swirl-

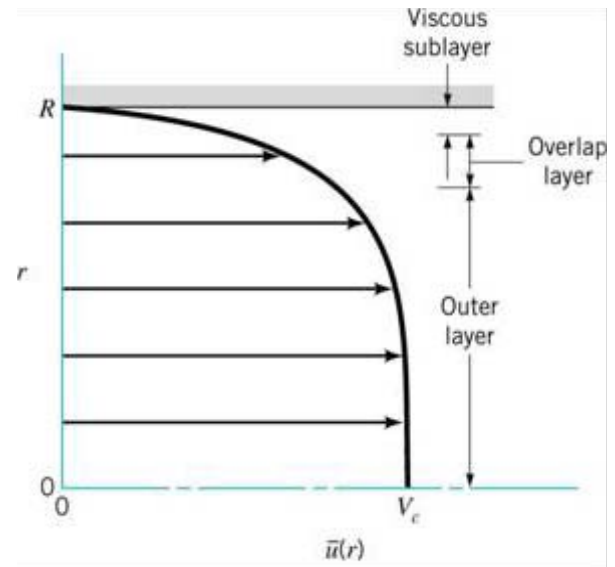

Figure 1. Fully-developed turbulent velocity profile from the axial centerline of pipe to the pipe wall. The profile is symmetrical about the pipe centerline¹.

free velocity profile to change to one that has two counter-rotating vortices (i.e., type-2 swirl) and an asymmetric or skewed velocity profile. This is the type of flow distortion that can introduce a bias into the flow rate measurement if the flow meter reads correctly when the flow field is “ideal.” The bias can be significant, on the order of several percent of reading, depending on the severity of the disturbance. Such a condition is typically referred to as an “installation effect.” In general, flow meter installation effects occur in three stages²:

1. The creation of velocity profile disturbances due to the effects of the piping configuration upstream of the flow meter. Common upstream piping configurations known to produce velocity profile distortions include a single elbow, two elbows in an in-plane configuration, two elbows in an out-of-plane configuration, and a partially-closed valve. Disturbed velocity profiles may be asymmetric, contain swirling motions (i.e., solid body rotation or two counter-rotating vortices), or have a combination of the two.
2. The decay of these velocity profile disturbances, usually as a result of turbulent diffusion and pipe wall friction. Different types of flow disturbances decay at different rates, but all

disturbances require relatively long lengths of straight pipe to re-establish a fully-developed, symmetric, swirl-free turbulent velocity profile. An example of the decay rate of a disturbance associated with a single elbow is shown in Figure 2. The velocity profile just downstream of the elbow has profile asymmetry plus two counter-rotating vortices. In this example, the effect persists for approximately 59 pipe diameters. Some disturbances, such as the one produced by two elbows out-of-plane (i.e., solid-body rotation or type-1 swirl), can persist for 200 pipe diameters or more.

3. The response of a specific flow meter to the velocity profile presented at the meter inlet. Some flow meters, such as orifice meters, are highly sensitive to distortions in velocity profile. Others, such as some ultrasonic meters, may be sensitive to velocity profile distortions, but include computational algorithms that may correct for some amount of flow distortion.

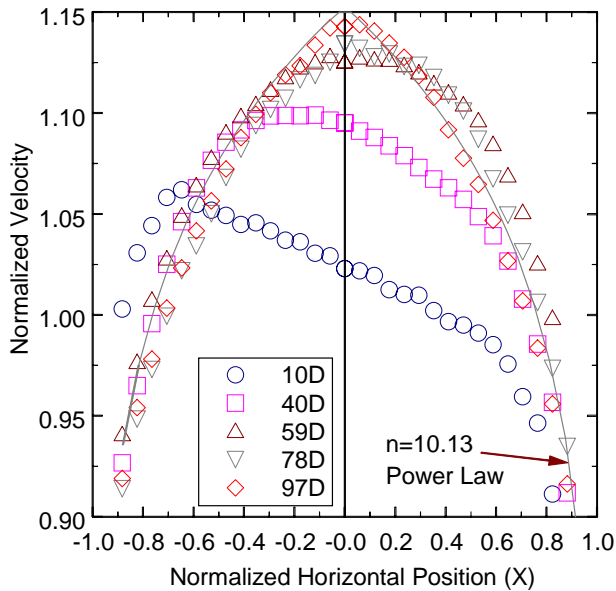

Figure 2. The decay of the effect of a single, 90° long radius elbow³.

Piping configurations showing a single elbow and two elbows out-of-plane are shown in Figure 3. Their associated velocity profiles at an axial distance approximately 10 pipe diameters downstream are shown in Figure 4. Note the combination of swirl and asymmetry produced by both configurations. These velocity profiles can cause significant flow rate measurement bias, depending on the response of the flow meter to disturbed velocity profiles.

Flow Conditioners

A flow conditioner can be used to offset the effect of flow field disturbances caused by the upstream piping and to reduce the amount of straight pipe length required to allow a flow distortion to fully dissipate. Flow conditioners adjust the flow field, ideally eliminating or greatly reducing the magnitude of the flow distortion caused by the upstream piping configuration. However, as will be shown later, there is no flow conditioner that can completely isolate a flow meter from all possible flow field distortions. Some “high-performance” conditioners are effective at “isolating” a fairly broad range of flow distortions propagating from upstream⁴. Figure 5 shows examples of several common flow conditioners.

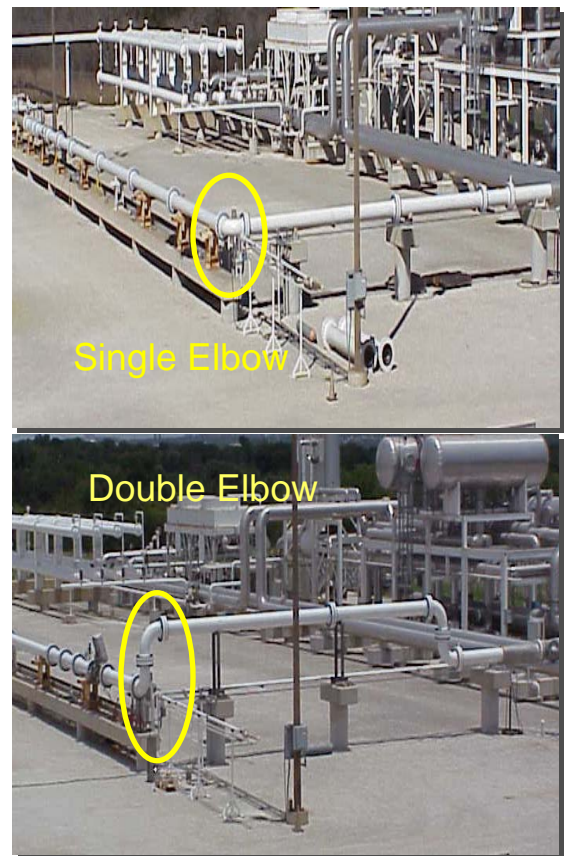

Figure 3. Two common upstream piping configurations.

ORIFICE METER INSTALLATION EFFECTS

The orifice meter is one of the oldest and most common flow meters in the natural gas industry. Tens of thousands of orifice meters are in service throughout the United States. Applications range from low volume, remote well-head flow measurement to high-volume pipeline custody transfer stations. Several types of orifice meter fittings are available. The two most common are the senior fitting, which provides the means to change orifice plates while the pipeline is under pressure, and the

flange fitting, in which the plate is permanently mounted between pipe flanges.

The orifice meter is categorized as a differential pressure producer. When the flow is accelerated through the orifice bore (i.e., a restriction in the flow stream), a differential pressure is produced across the orifice plate that is related to the flow rate through the orifice. Figure 6 illustrates the differential pressure created across an orifice plate.

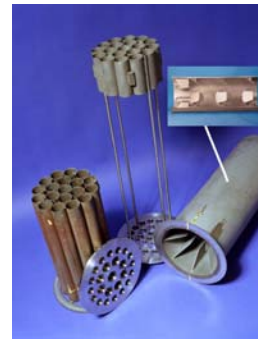

Figure 5. Example flow conditioners (from left to right: 19-tube bundle, Canadian Pipeline Accessories CPA 50E Plate, Gallagher Flow Conditioner TAS, and Vortab Flow Conditioner).

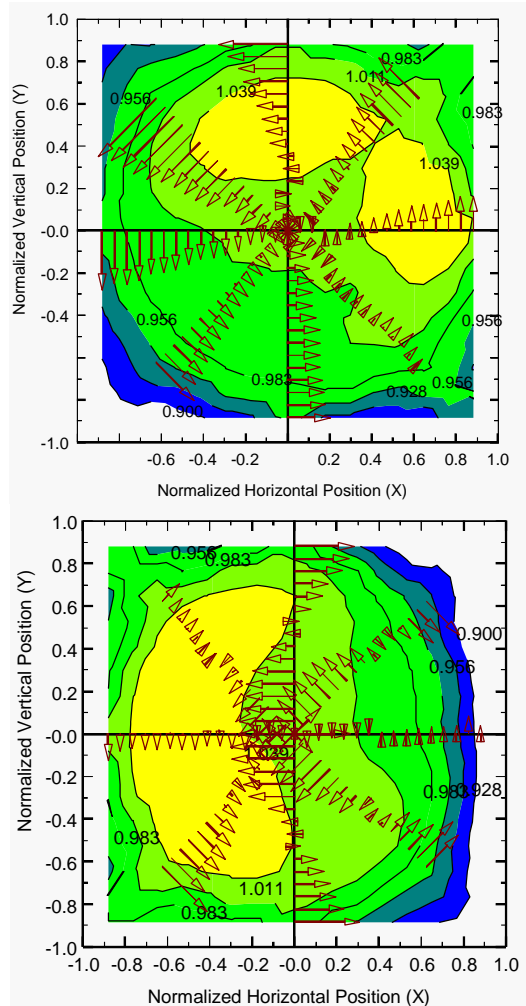

Figure 4. Velocity profile asymmetry and swirl 10 pipe diameters downstream of (1) two elbows out-of-plane (top) and (2) a single 90° elbow (bottom). Note high amount of swirl represented by the velocity vectors and velocity profile asymmetry represented by contour line shifts (and changes in color) away from the axial centerline (i.e., center of the grid)⁵.

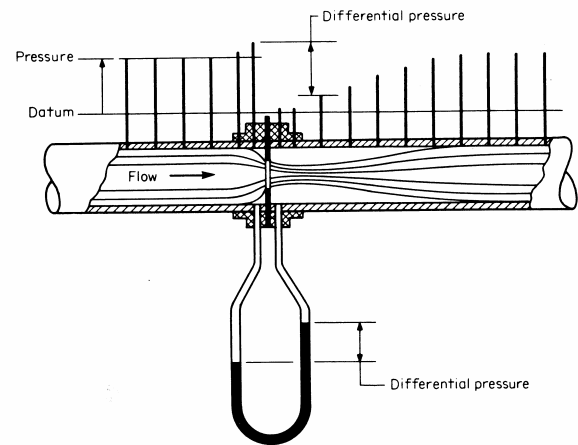

Figure 6. The differential pressure created as flow is accelerated through an orifice).

The orifice flow rate equation is as follows:

$$q_m = N_1 C_d E_V Y d^2 \sqrt{\rho_{t,P} * \Delta P} \quad \text{Equation 1}$$

Where:

- q_m is the mass flow rate, in lb_M/s ,
- N_1 is a unit conversion factor (for the units given here, $N_1 = 6.30025$),
- C_d is the orifice plate discharge coefficient and is non-dimensional,
- E_V is a velocity of approach factor and is non-dimensional,
- Y is an expansion factor ($Y = 1.0$ for incompressible fluids, but $Y < 1$ for natural gas. The expansion factor is non-dimensional),
- d is the orifice plate bore diameter in feet,
- D is the meter tube diameter in feet,
- β is the beta ratio, d/D (β is non-dimensional),
- $\rho_{t,P}$ is the density of the fluid in lb_M/ft^3 ,
- ΔP is the orifice differential pressure in lb_f/ft^2 .

Orifice Discharge Coefficient

The orifice equation calculates the actual flow rate when the assumptions associated with its derivation are true. One of the principal effects on accuracy is the geometry of the orifice bore⁶. The flow restriction produced by the orifice creates a significant change in flow direction – commonly referred to as the vena contracta. In this region of the flow field, the streamlines of the flow contract and energy is lost to recirculation zones located immediately upstream and downstream of the orifice plate. These recirculation zones are created when the boundary layer of the flow separates from the pipe wall. An empirically-derived discharge coefficient, C_d , accounts for this effect in the orifice flow rate equation (Equation 1).

The discharge coefficient is defined as the ratio of the actual flow rate to the theoretical flow rate. For orifice meters, the discharge coefficient is typically around 0.6. The U.S. gas industry uses the Reader-Harris/Gallagher (R-G) equation to calculate the discharge coefficient. The R-G equation was derived using a database of discharge coefficient measurements taken by flow laboratories around the world. The discharge coefficients included in the database were measured when the pipe flow had a fully-developed, symmetric, swirl-free, turbulent velocity profile. Figure 7 shows discharge coefficients measured at several labs around the world, compared with the R-G equation and its 95% confidence interval. With respect to installation effects, the discharge coefficient calculated using the R-G equation will likely differ from the actual discharge coefficient if the turbulent velocity profile is not fully-developed, symmetric, and swirl-free.

Installation Effects Tests

Between 1987 to 2000, Southwest Research Institute and several other research organizations, such as the NOVA Technology Center in Canada and the National Institute for Standards Technology (NIST), conducted a comprehensive test program to quantify the effect of upstream piping installations on the orifice discharge coefficient. Tests were conducted under various disturbed velocity profile conditions. The test matrix included the use of several beta ratios and pipe diameters, with and without flow conditioners installed upstream of the test flow meters. The purpose of this work was to determine the appropriate length of straight pipe required upstream of the flow meter and the appropriate placement of a flow conditioner, when used, to produce a discharge coefficient that agreed with the calculated discharge coefficient within the 95% confidence interval of the R-G equation. This research was conducted in support of the 2000 revision of AGA Report No. 3, *Orifice Metering of Natural Gas and Other Related Hydrocarbon Fluids*. Figure 8 shows the results of one of the installation effects tests conducted at SwRI.

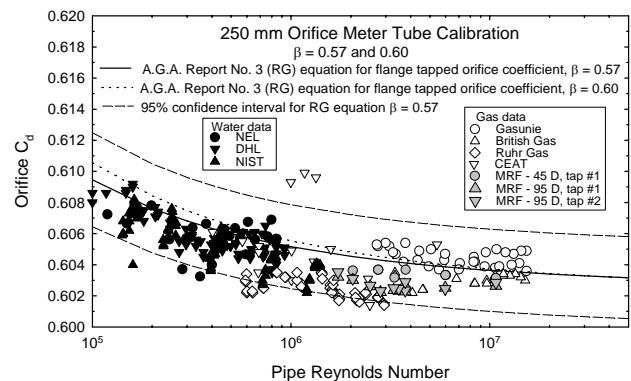

Figure 7. Orifice discharge coefficient data from several flow laboratories, compared with the R-G equation and its 95% confidence interval.

Design Guidelines – AGA Report No. 3

The gas industry standard for orifice meter installations, American Gas Association (AGA) Report No. 3, Part 2⁷, was revised in 2000 to reflect the results of the preceding installation effects research. The revised standard included a recommendation for the minimum length of straight pipe required upstream of an orifice meter when no flow conditioner is used (up to 145 diameters of pipe may be required ahead of the meter). Figure 9 shows the typical bare-tube installation configuration recommended in the standard. The minimum recommended length of straight pipe between the orifice meter and several common flow distorting configurations are also provided (see Table 1). A “catch-all” category was also provided for upstream piping configurations not specifically referenced in the standard, such as complex headers found in many meter stations.

For installations utilizing a 19-tube bundle (Figure 10), the upstream lengths of straight pipe are reduced to a maximum of 14.5 diameters for an upstream disturbance caused by two elbows out-of-plane when the upstream length is between 17 and 29 pipe diameters and the β ratio is 0.67 or less (Table 2).

ULTRASONIC METER INSTALLATION EFFECTS

The ultrasonic meter is now a fairly common custody transfer meter in the gas transmission segment of the natural gas industry. It is gradually making its way into applications further upstream and downstream as well. The ultrasonic meter is a relatively new technology. It has been used for natural gas custody transfer for only about ten years in the United States. Initial entries into the market carried claims of extremely high turndown ratios (on the order of 100:1) and insensitivity to velocity profile variations. Research performed by SwRI and others determined that these meters were capable of accurate measurement at turndown ratios closer to 20:1 and quantified their sensitivity to velocity profile distortions (i.e., installation effects).

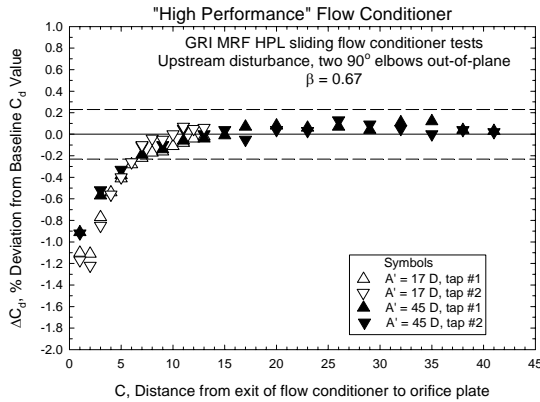
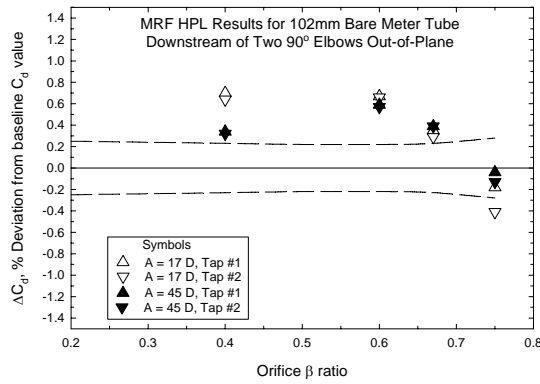

Figure 8. Example of the shift in orifice C_d for two elbows out-of-plane. The upper figure shows the β ratio dependence of the C_d shift for bare meter tubes with 17 and 45 diameters of straight pipe upstream of the meter. The lower figure shows the effect of placing a “high performance” flow conditioner at various locations between the orifice and the element(s) that produced the upstream flow disturbance.

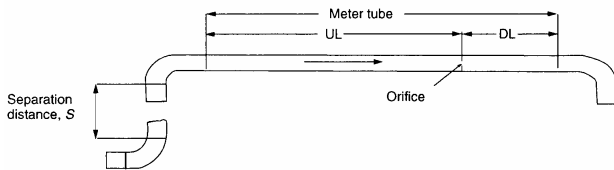

Figure 9. Bare Orifice Meter Tube Installation.⁸

Distortion Source	Recommended Upstream Length (UL) for Maximum β Range (Bare Meter Tube)
Single 90° elbow	44 D
Two 90° elbows out-of-plane, < 5 D apart	95 D
Single 90° tee used as an elbow	44 D
Gate valve at least 50% open	44 D
Any other configuration	145 D

Table 1. Upstream Lengths Required for Orifice Meters Without a Flow Conditioner⁹.

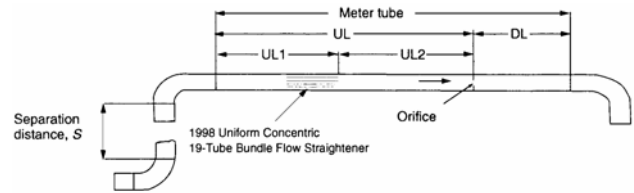

Figure 10. Orifice Meter Tube Installation with 19-Tube Bundle¹⁰.

Distortion Source	Recommended Upstream Length (17D ≤ UL ≤ 29D) for Maximum β Range (19-Tube Bundle)
Single 90° elbow	13 D ($\beta \leq 0.67$)
Two 90° elbows out-of-plane, ≤ 2 D apart	13.5 to 14.5 D ($\beta \leq 0.67$)
Single 90° tee used as an elbow	13 D ($\beta \leq 0.54$)
Gate valve at least 50% open	9.5 D ($\beta \leq 0.47$)
Any other configuration	9.5 D ($\beta \leq 0.46$)

Table 2. Upstream Lengths Required for Orifice Meters With a 19-Tube Bundle Flow Conditioner¹¹.

An ultrasonic meter infers the flow rate by measuring the time interval it takes for a high-frequency (i.e., ultrasonic) pulse of energy to travel through a flowing gas stream. This interval is commonly referred to as the “transit time.” Ultrasonic pulses are transmitted diagonally across the pipe by transducer pairs (Figure 11). Each transducer alternates as a receiver and transmitter. When the pulse travels in the direction of the flow, the pulse velocity equals the velocity of sound of the flow stream, plus the velocity of the flowing gas. When the pulse reverses direction, the pulse velocity equals the velocity of sound minus the velocity of the flowing gas. The transit time of the pulse traveling in the direction of the flow is shorter than the transit time of the pulse traveling in the opposite direction. The difference in transit time is used to infer the velocity of the fluid stream.

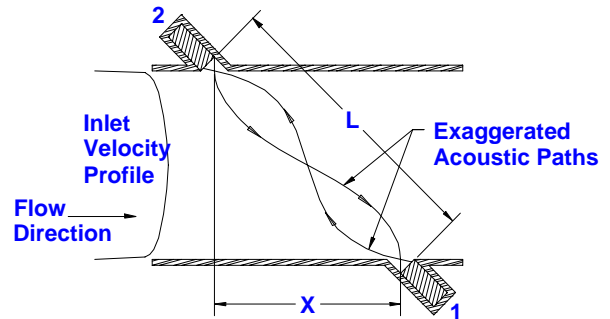

Figure 11. Ultrasonic meter operating principle.

Ultrasonic meters used for custody transfer typically have several pairs of ultrasonic transducers. These “multi-path” meters use different path configurations to sample a

larger portion of the velocity profile than the simpler “single-path” meter discussed previously. Figure 12 shows two common ultrasonic meter acoustic path geometries: the chordal-path and the bounce-path. The chordal-path meter essentially “slices” the velocity profile to determine the velocity across the cross-section of the pipe. The bounce-path configuration uses reflections of the ultrasonic pulse off the pipe wall to extend the transit time interval. Because multi-path meters provide improved resolution of the velocity profile, manufacturers have developed some relatively crude methods to infer swirl and velocity profile asymmetry, thereby reducing (but not eliminating) the sensitivity of this type of meter to changes in the velocity profile.

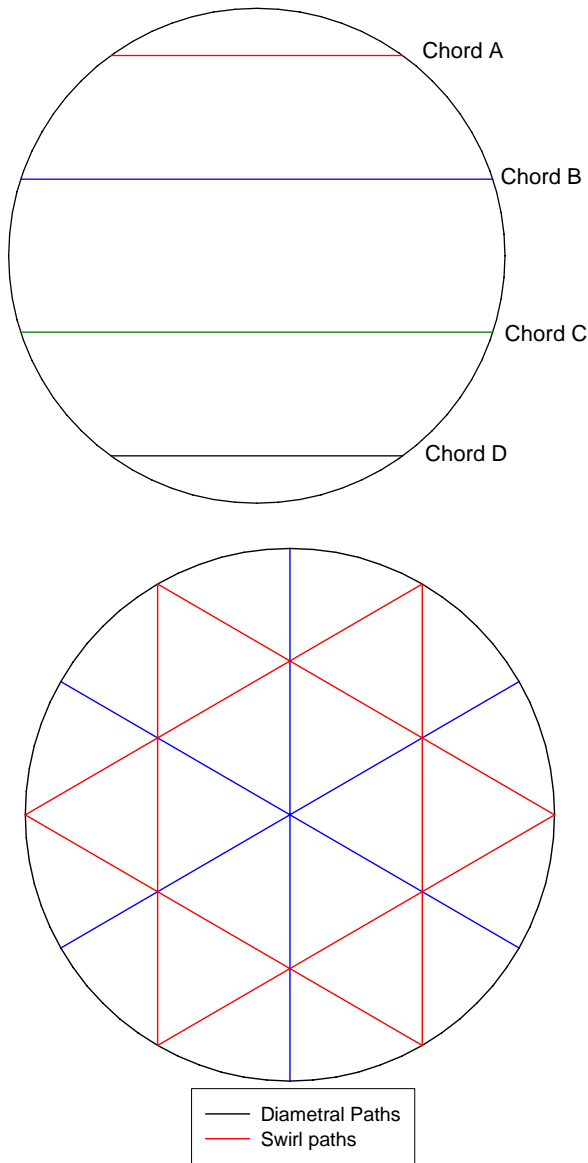

Figure 12. Two common ultrasonic meter path geometries. The chordal-path geometry is shown first. The bounce-path geometry is shown second.

Since the velocity across the pipe cross-section varies, the velocities associated with each path must be combined to provide an average or bulk velocity that can be used to calculate the volumetric flow rate. To determine the average velocity, each manufacturer uses a proprietary method for weighting the effect of the individual paths. For the chordal-path meter, weighting factors are based on a numerical integration method that specifies the path locations. In this case, the integration method is independent of the velocity profile. For the bounce-path, the integration method is likely dependent on the velocity profile. Some weighting factors may be functions of Reynolds number and others may combine the individual path measurements. The combination of the individual path measurements may be based on recognition of flow characteristics determined by the individual acoustic path measurements. In general, the average volumetric flow rate is calculated using the following equation (the summation determines the average velocity):

$$q_v = \frac{\pi}{4} D^2 \cdot \sum_{i=1}^n W_i \frac{L_i^2}{2X_i} \frac{\Delta t_i}{t_{i1}t_{i2}} \quad \text{Equation 2}$$

Where:

- q_v is the volumetric flow rate, in ft³/s,
- L_i is the path length of path i ,
- X_i is the axial length of path i ,
- Δt_i is the differential transit time of path i ,
- t_{i1} is the transit time for downstream transducer on path i ,
- t_{i2} is the transit time for upstream transducer on path i ,
- W_i is the weighting factor on path i ,
- D is the meter internal bore diameter.

Installation Effects Tests

Research conducted by SwRI has shown that the shape of the velocity profile can introduce bias in ultrasonic flow measurement. Flow conditioners generally improve meter performance but can adversely impact flow measurement accuracy as well. Figure 13 shows the performance of a bounce-path multi-path ultrasonic meter located downstream of two elbows out-of-plane. The graph shows that the bias introduced by the two elbows is approximately 1 percent relative to the undisturbed baseline.

Figure 14 shows relative meter performance when flow conditioners are used. In these natural gas flow tests, the piping configuration upstream of each flow conditioner produced a fully-developed, symmetric, swirl-free turbulent velocity profile. The test results suggest that each flow conditioner produces its own characteristic velocity profile downstream and may not completely

“isolate” the meter from distortions in the upstream velocity profile. Therefore, it is generally recommended that ultrasonic flow meters be flow calibrated with the meter tube and flow conditioner combined. This will ensure optimal calibration accuracy and transferability from the flow laboratory to the field.

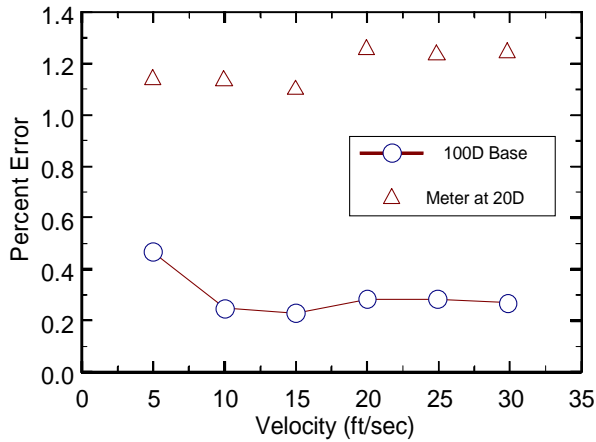

Figure 13. Example of the change in multi-path (bounce-path) meter performance associated with two elbows out-of-plane with a bare meter tube.

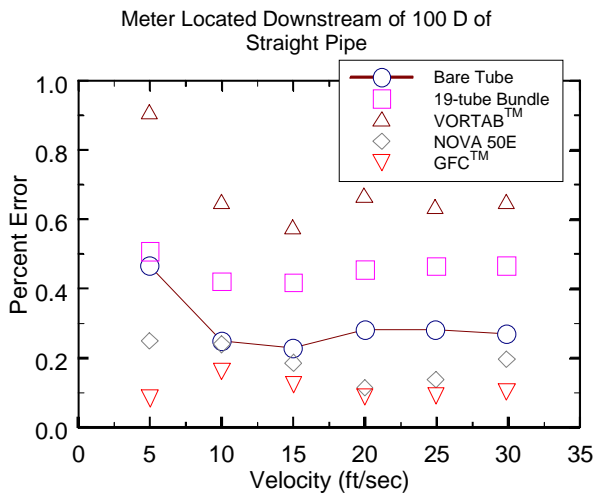

Figure 14. Example of the change in meter performance associated with installing flow conditioners. Note that each flow conditioner impacts the meter differently. (For best performance, the meter should be calibrated with the meter tube and the flow conditioner.)

Design Guidelines – AGA Report No. 9

The gas industry standard for ultrasonic flow measurement is American Gas Association Report No. 9, *Measurement of Gas by Multipath Ultrasonic Meters*. AGA Report No. 9 is a performance-based recommended practice, meaning that the performance of the meter and meter installation must fall within certain accuracy

specifications, regardless of the meter path geometry and the upstream piping. A performance-based standard or guideline is necessary when meters that have the same basic operating principle are designed with different physical configurations, such as the chordal-path and the bounce-path ultrasonic meter geometries. This is different from AGA Report No. 3, the orifice meter standard, which specifically defines the acceptable upstream piping configurations.

The standard discusses protrusions into the flow, surface roughness, vibrations, thermal wells, velocity profile considerations and the use of flow conditioners. The standard provides guidelines for meter testing under non-flowing as well as flowing conditions. The next revision of Report No. 9 most likely will require flow calibration for custody-transfer meters and should also provide general meter calibration requirements.

TURBINE METER INSTALLATION EFFECTS

The turbine meter is another common flow meter. It is one of the most accurate and repeatable flow meters available for custody transfer. Turbine meters have fairly high flow rate capacity, good long-term and short-term repeatability, and are usually linear above the first 10 to 20% of the flow rate range.

Figure 15 shows the components of a typical turbine flow meter. The meter consists of a body, a rotor supported by bearings, an inlet nose cone, and an electronic or mechanical readout. Turbine meters measure flow rate by counting the number of revolutions of a rotor that spins as the gas flows across its blades. The annular passage created by the nose cone accelerates the flow, providing increased torque to drive the rotor and improve meter performance at lower flow rates¹². The meter may include an electronic sensor to divide a revolution of the rotor into pulses. The readout counts the pulses and converts them into the indicated volume flow rate through a derived factor known as the Reference Pulse Factor or “K-factor.”

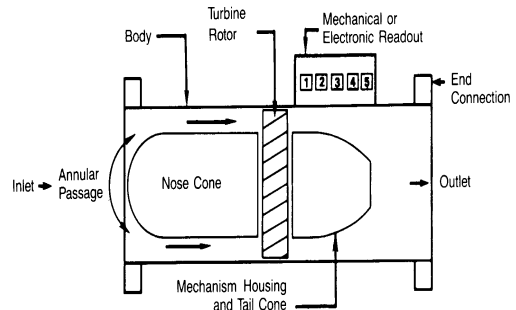

Figure 15. A typical turbine meter configuration¹³.

The reference pulse factor and indicated volume flow rate equations for a turbine meter are:

$$\text{Reference Pulse Factor} = K = \frac{n \omega}{2\pi Q} = \frac{N \text{ (pulses)}}{\text{Reference Volume (ft}^3\text{)}} \quad \text{Eq. 3}$$

$$\text{Indicated Volume Flow Rate} = \frac{N \text{ (Pulses)}}{K \text{ (Pulses/ft}^3\text{)}} \quad \text{Eq. 4}$$

Where:

- K is the meter “K-factor,” determined by calibration, in pulses/ft³,
- n is the number of pulses per rotor revolution,
- ω is the rotational velocity of the rotor in radians/s,
- Q is the reference flow measurement from the calibration facility, accumulated during the calibration, in ft³,
- N is the number of meter output pulses accumulated during the calibration.

The K-factor is determined by calibrating the meter under flowing conditions. Most turbine meter manufacturers perform their own calibrations, typically with air as the test medium. Other flow laboratories can also provide flow calibration services, usually with fluids such as natural gas, and at conditions more closely resembling actual operating conditions. The flow laboratory selected to perform the calibration should be able to demonstrate traceability of their reference measurements to a national standard, minimizing the chance of introducing bias errors into the meter K-factor through an inaccurate reference measurement. During a flowing calibration, reference flow rate data and accumulated meter pulses are collected and used to derive the meter K-factor in pulses per cubic foot.

The indicated volumetric flow rate is determined by dividing the total accumulated pulses by the K-factor. At a given flow rate, if the velocity profile differs from the velocity profile that existed during calibration, the number of pulses accumulated while in service may differ from the number of pulses accumulated during calibration, introducing a bias error into the indicated volumetric flow rate. This can occur if a distorted velocity profile exists at the meter inlet.

Installation Effects Tests

Experiments have shown that turbine meters can be sensitive to velocity profile distortions, particularly highly swirling flows, such as those produced downstream of two elbows oriented out-of-plane. In general, flow swirling in the direction of rotor rotation tends to impart momentum to the rotor, causing a positive measurement bias, while flow swirling in the direction opposing rotor rotation causes a negative bias^{14,15}. The effect of the upstream piping installation on the magnitude of meter bias ranges from 0.35% to over 5.5% and appears to depend on meter design (e.g., annular passage geometry, rotor design, integral flow conditioner design, etc.).

Meters with integral flow conditioners tend to be less sensitive to flow distortions resulting from the upstream piping configuration. In general, flow conditioners improve meter performance.

Figure 16 shows the effect of two elbows oriented out-of-plane, producing swirling flow, on a turbine meter K-factor and the effect of a flow conditioner on the K-factor as a function of swirl angle. In this case, the shift in K-factor increases as the meter is located closer to the disturbance and as the disturbance becomes more severe. The effect of a flow conditioner limits the K-factor shift to a maximum of approximately 1.5% of reading at a swirl angle of 30°. Without any flow conditioner installed upstream, the meter produces a measurement bias error of over 5.5%.

Additional research suggests that turbine meters are sensitive to distorted velocity profiles produced by asymmetric or jetting flows. Under asymmetric or jetting flow conditions, such as is produced by a partially-closed gate valve or a pipe obstruction, the highest velocity in the pipe cross-section tends to dominate, resulting in a positive measurement bias¹⁶.

In 2003, SwRI conducted installation effects tests on five, commercially-available turbine meters in support of the revision of AGA Report No. 7, *Gas Flow Measurement by Turbine Meters*. Three piping installation configurations prescribed in the standard were tested under symmetric, swirl-free, fully-developed turbulent flow conditions as well as severely distorted flow conditions. The piping configurations included the AGA-7 “recommended” meter installation configuration, as well as the “close-coupled” and “short-coupled” configurations. The piping upstream of the meter ranged from a high-performance flow conditioner followed by 30 diameters of straight pipe (which provided a symmetric, swirl-free, fully-developed turbulent velocity profile¹⁷) to the “high-perturbation” configuration described in ISO Standard 9951, *Measurement of Gas Flow in Closed Conduits – Turbine Meters* (which produced an asymmetric, clockwise swirling flow leading into the clockwise-rotating turbine rotor). The research concluded that the total installation effect on the AGA-7 installation configurations, including the effect of the “high-perturbation” condition, was less than +/-1% of reading. Meters with integral flow conditioning were shown to limit the installation effect to approximately +/-0.25%¹⁸.

Design Guidelines – AGA Report No. 7

The gas industry recommended practice for turbine flow measurement is American Gas Association Report No. 7, *Measurement of Gas by Turbine Meters*. Although this report is a recommended practice, it essentially serves as a defacto standard for the U.S. natural gas industry. The most recent edition was published in 1996. A revision of the report is expected to be published sometime in 2006.

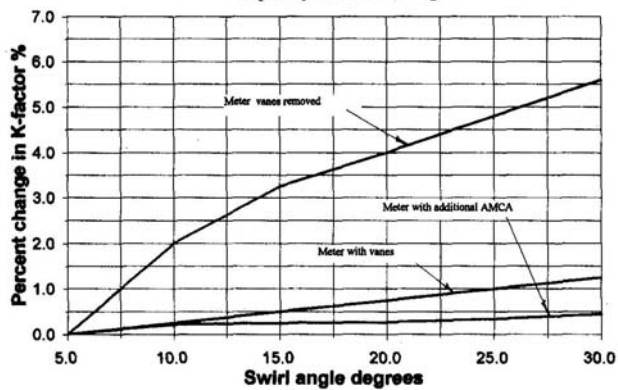
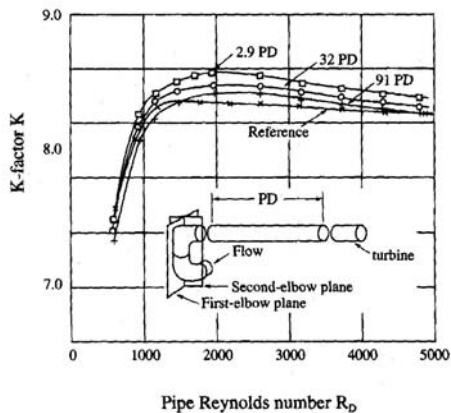

Figure 16. The effect of two elbows oriented out-of-plane (left), on a turbine meter K-factor and the effect of a flow conditioner on the K-factor (right) as a function of flow swirl angle¹⁹.

The document provides recommended installations, such as those tested during the SwRI research discussed earlier. It also provides guidance for installing flow conditioners, strainers, filters, and secondary instrumentation (i.e., pressure and temperature measurement devices). In addition, the report provides guidance on protecting turbine flow meters from being over-ranged. It describes the potential adverse effect of velocity profile distortion on meter accuracy and information on proper meter calibration.

INSTALLATION EFFECTS ASSOCIATED WITH SECONDARY INSTRUMENTATION

Installation effects impacting flow measurement accuracy are not limited to flow meters. The accuracy of secondary instrumentation, such as static pressure and gas temperature measurement devices (i.e., values used in the calculation of gas compressibility or density) and differential pressure measurement devices (i.e., a value used in the orifice flow equation), can be adversely affected by their installations. These installation effects, however, are not the result of velocity profile disturbances. In some cases, such as when measuring static or differential pressure, the installation effect is the result of the fabrication process. In other cases, such as

the measurement of the gas temperature, the installation effect is the result of the measurement method (e.g., the use of thermal wells) and the operating conditions, (i.e., the flowing gas and ambient temperatures).

Temperature Measurement

In most gas flow applications, the temperature measurement device, usually a resistance temperature device (RTD) is inserted in a housing called a thermal well. This type of installation can adversely affect the accuracy of the temperature measurement. Recent computational fluid dynamic simulations²⁰ have shown that the temperature of the thermal well can be affected by the pipe wall temperature, when it deviates from the flowing gas temperature and when flow rates are relatively low (i.e., less than about 2 ft/s nominal or bulk gas velocity). Since the RTD is in direct contact with the thermal well, the measured temperature can be affected. Figure 17 shows the effect of pipe wall temperature and gas velocity on the temperature of the thermal well immersed in a flowing natural gas stream. Note that the pipe wall temperature and the flowing gas temperature are equal in both cases.

In addition to the effect of pipe wall temperature on the temperature of the thermal well, there is potential for thermal stratification when the pipe wall or ambient temperature differs from the flowing gas temperature. Figure 18 shows the temperature profile of a low velocity (0.5 to 1.0 ft/s) natural gas flowing in a 12-inch diameter pipe when the ambient temperature is 18°F below the nominal flowing gas temperature. The temperature profile shows that differences from the nominal flowing gas temperature ranging from 7°F to less than 1°F occur along the cross-section of the pipe. Under these conditions, a temperature error could be introduced into the flow measurement, even if the thermal well is unaffected by the pipe wall temperature.

Static and Differential Pressure Measurement

The static pressure is used in the compressibility calculation and to account for expansion of the meter body due to circumferential strain. The differential pressure is used to measure the pressure drop across a meter such as an orifice meter. It is usually assumed that pressure taps drilled through holes that are perfectly normal to the pipe wall will provide an accurate measurement of static pressure and that any deviations from this ideal can be adjusted through calibration²¹. However, when a meter calibration is not required, such as with an orifice meter, these errors become part of the overall meter error. Figure 19 shows estimated effects of pressure tap geometry on the static pressure measurement, relative to a reference condition²². In general, rounded pressure taps tend to cause a positive bias error, and countersunk pressure taps tend to cause a negative bias.

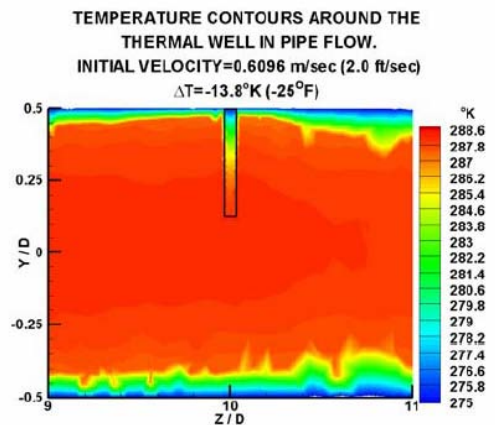
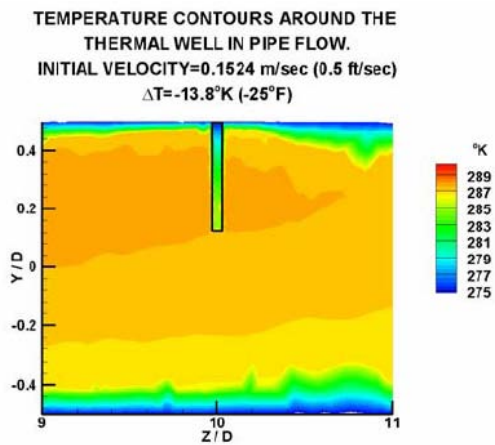

Figure 17. The effect of pipe wall temperature and velocity on thermal well temperature when the pipe wall temperature is below the flowing gas temperature. The tip of the thermal well is approximately 5°F (3°K) cooler than the gas at 0.5 ft/s. The tip of the thermal well is about equal to the flowing gas temperature at 2.0 ft/s²³.

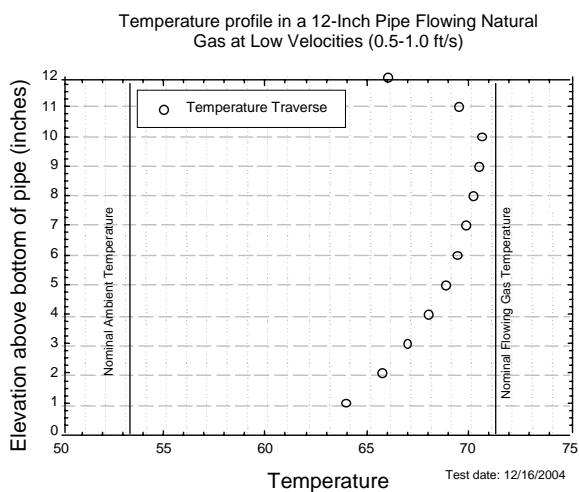

Figure 18. Temperature stratification in a 12-inch pipe flowing low velocity natural gas when the ambient temperature is lower than the flowing gas temperature.

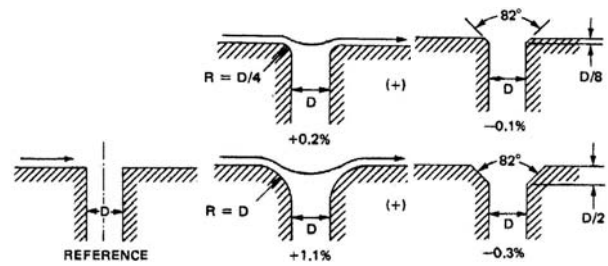

Figure 19. Estimated errors in measured pressure associated with different pressure tap geometries. The left figure is the ideal; the middle figure shows the effect of rounded corners, relative to the ideal. The right figure shows the effect of countersinking, relative to the ideal²⁴.

CONCLUSIONS

The configuration of the piping upstream of a flow meter can cause distortions in the velocity profile that may result in bias errors in the flow rate measurement. The velocity profile can be affected by the upstream piping configuration through the establishment of axial rotation or by the redistribution of momentum along the pipe cross-section. Swirling flow or velocity profile asymmetry or a combination of the two can result. Typical piping configurations that cause these disturbances include single elbows, two elbows in an in-plane configuration, two elbows oriented out-of-plane, partially closed valves, and other obstructions in the pipe flow. Flow distortions can persist for as much as 200 diameters. The persistence of some types of flow disturbances suggests that potential sources of velocity profile distortion further upstream than the immediate meter run should be investigated if piping installation effects are a concern.

The effect of velocity profile disturbances on flow measurement accuracy may be different for each meter type. In the case of orifice meters, the impact of velocity profile distortions is due to the fact that the R-G equation used to determine the discharge coefficient value implicitly assumes that the velocity profile is fully-developed, symmetric, swirl-free, and turbulent. In the case of ultrasonic meters, the number of paths and the method of “integrating” the velocity profile impacts the ability of the meter to resolve and recognize distorted velocity profiles. In the case of turbine meters, velocity profile distortions tend to either increase or decrease rotor momentum, resulting in over- or under-measurement. Installation effects on ultrasonic and turbine meters tend to depend on the specific meter design.

Flow conditioners can be used to mitigate the effects of upstream flow disturbances, allowing for the use of shorter lengths of straight upstream pipe, but flow conditioners do not truly isolate the flow meter from the

upstream flow field. While the use of a flow conditioner is recommended with all meter types, the meter station designer or operator should be aware that some flow conditioners may “freeze” velocity profile asymmetry, allowing it to continue on downstream, while others may introduce bias errors into the flow measurement due to their ability to produce a pseudo fully-developed velocity profile downstream of the conditioner.

While the piping installation configuration upstream of a flow meter may adversely affect meter accuracy through the creation of flow distortions, installation effects may also adversely affect the accuracy of secondary element measurements, such as static or differential pressure measurement devices and flowing temperature measurement devices. The accuracy of these secondary measurement devices affects the accuracy of the total energy flow rate calculation because of their use in the gas compressibility (i.e., gas density) calculation and the flow rate calculation.

REFERENCES

1. Roney, Jason, MAE 3130 *Course Lecture 10 – Spring 2003*, Mechanical and Aerospace Engineering, University of Colorado at Colorado Springs.
2. Steenbergen, W., *Turbulent Pipe Flow with Swirl*, Thesis, Eindhoven University of Technology.
3. Grimley, T.A., *Performance Testing of 8-inch Ultrasonic Flow Meters for Natural Gas Measurement*, Topical Report to Gas Research Institute, GRI Contract No. 5097-270-3937, November 2000.
4. Bowles, E.B. and D.L. George, *Effects of Flow Conditioning on Gas Measurement*, ISHM Class No. 8050.
5. Ibid.
6. Miller, R.W., *Flow Measurement Engineering Handbook, 3rd edition*, McGraw-Hill.
7. AGA Transmission Measurement Committee Report No. 3, *Concentric, Square-Edge Orifice Meters*, AGA, Arlington, VA, June 2000.
8. AGA Transmission Measurement Committee Report No. 3, *Concentric, Square-Edge Orifice Meters*, AGA, Arlington, VA, April 2002.
9. AGA Transmission Measurement Committee Report No. 3, *Concentric, Square-Edge Orifice Meters*, AGA, Arlington, VA, April 2002.
10. AGA Transmission Measurement Committee Report No. 3, *Concentric, Square-Edge Orifice Meters*, AGA, Arlington, VA, April 2002.
11. AGA Transmission Measurement Committee Report No. 3, *Concentric, Square-Edge Orifice Meters*, AGA, Arlington, VA, April 2002.
12. Miller, R. W.
13. AGA Transmission Measurement Committee Report No. 7, *Measurement of Gas by Turbine Meters*, AGA, Arlington, VA, April, 1996
14. Brennan, J.A., S.E. McFaddin, C.F. Sindt, and K.M. Kothari, *The Influence of Swirling Flow on Orifice and Turbine Flowmeter Performance*, *Journal of Flow Measurement and Instrumentation*, Volume 1, October, 1989.
15. Van Dellen, K. and P.M.A. Vanderkam, *The Effect of Double Bends Out of Plane on Turbine Meters*, N.V. Nederlandse Gasunie.
16. McKee, Robert, Principal Engineer, Southwest Research Institute, *Personal Communication*.
17. George, D.L., *Metering Research Facility Program: Turbine Meter Research in Support of the Planned AGA Report No. 7 Revision*, Topical Report to Gas Research Institute, GRI Contract No. 8346, January 2003.
18. Ibid.
19. Miller, R. W.
20. Morrison, Gerald R. and Pardeep Brar, “CFD Evaluation of Pipeline Gas Stratification at Low Flow Due to Temperature Effects.” Final Report to Gas Research Institute, GRI Contract No. 8733, September 2004.
21. Mattingly, G.E., *Volume Flow Measurements*, in *Fluid Mechanics Measurements*, Edited by Goldstein, R.J., Hemisphere Publishing Corporation, 1983
22. Ibid.
23. Ibid.
24. Ibid.