

# FUNDAMENTALS OF NGL METER STATION DESIGN

Tony Lockard  
Doug Patel

Enterprise Products

## Overview

This paper provides a fundamental overview of an NGL meter station design reviewing the nuances of configuring similar components in different ways. There are multiple considerations that influence the meter station design and all must be taken into account. Major considerations are: what product or products will be measured, what meter technology to utilize, and the process design limitations.

The first thing that must be taken into account is whether the product is a purity product or a mixed compositional product. Most purity products are measured and accounted for by volume, while a mixed compositional product is measured and accounted for by mass. This influences the meter skid design, since mass product skids must be set-up to allow for the stream's mass and stream's composition to be measured properly.

The second consideration that influences the skid design is the meter technology chosen. The skid components required can change depending on the meter technology selected. There are numerous meter technologies available on the market, but the three major meter technologies commonly used for NGL custody measurement are Turbine meters, Coriolis meters, and Positive Displacement (PD) meters.

Other minor considerations will be discussed at the appropriate times throughout the paper.

## Discussion

### Volumetric Meter Station Design

Figure 1 below is a layout for a typical uni-directional volumetric meter skid. Examples of purity products: Propane, Butane, iso-Butane, Natural Gasoline.

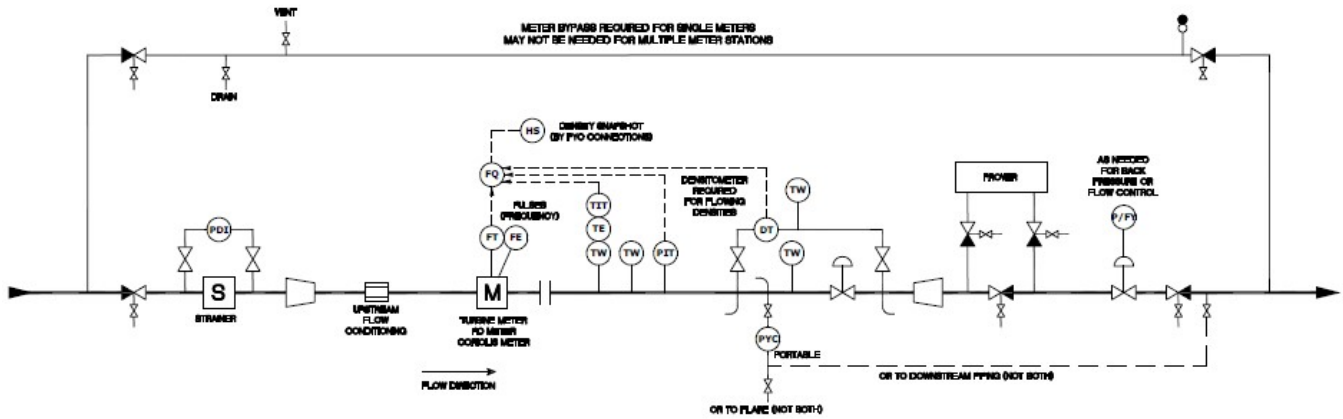
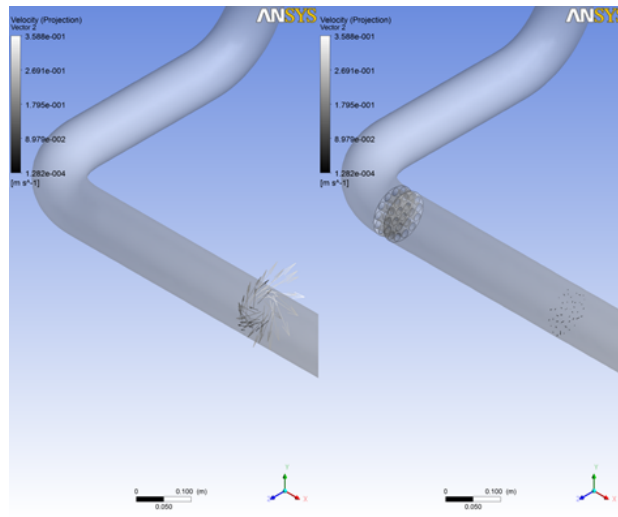


Figure 1 – Typical Volumetric Measurement Skid

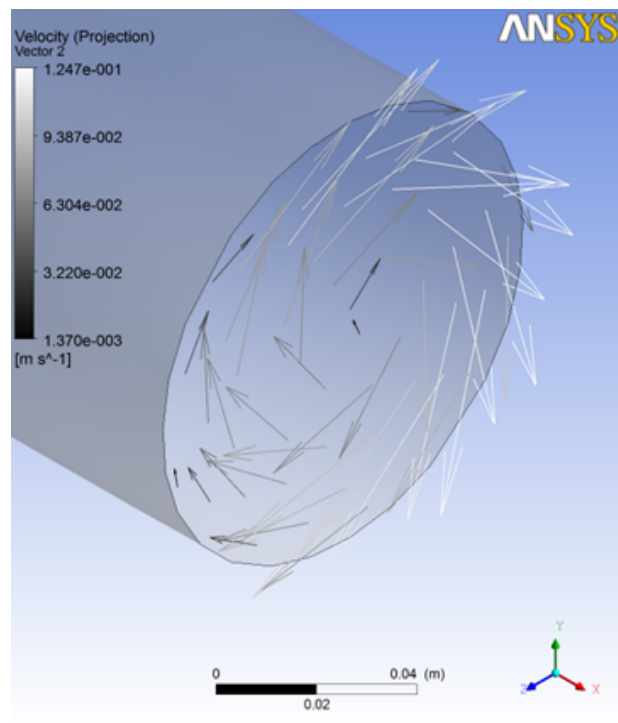
The components required include: strainer, flow conditioner, meter, temperature transmitter, pressure transmitter, densitometer, prover, and a back pressure control valve. These components will be discussed in the order as installed on the meter run piping.

A strainer should be considered on each meter installation to ensure no debris enters the meter run. Depending on the meter technology chosen, debris entering the meter could lead to mis-measurement, premature meter failure, or both. For example, the performance of a positive displacement meter is significantly impacted by the cleanliness of the product stream being measured.

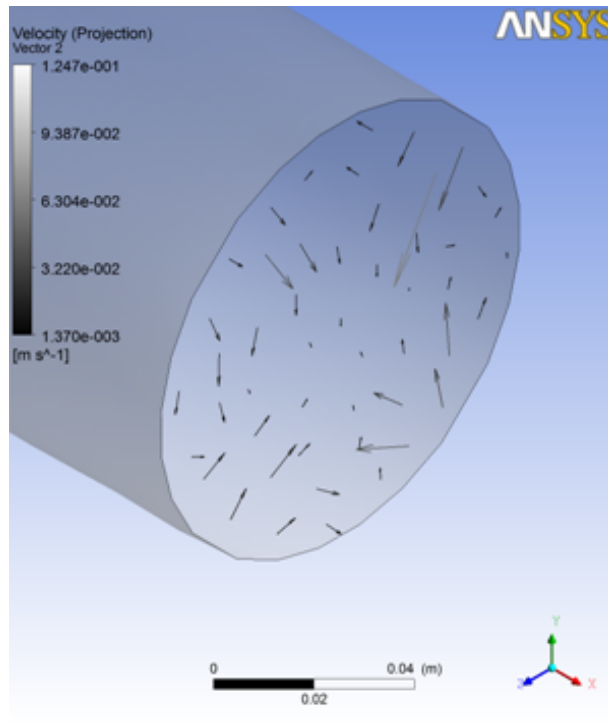
In a volumetric station with mechanical meters, the performance can be negatively affected by flow profile distortions (swirl) created by piping effects prior to entering the meter. As a result, the amount measured can be in error and is dependent on the direction and amplitude of the distortion. A general rule of thumb is that 30 pipe diameters of straight pipe is required to straighten most flow profile distortions; however, depending on the severity of the distortion, significantly more pipe diameters may be required before the flow profile returns to normal. Some data indicates significant swirl induced by piping effects can persist for more than 200 pipe diameters.



**Figure 2 – Comparison of Flow Disturbances No Flow Conditioning Vs. Flow Conditioning**

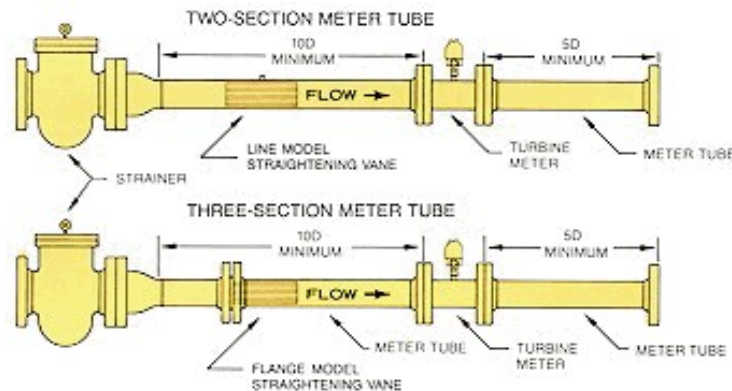


**Figure 3 – Product Swirl from Installation Effect with No Flow Conditioning**



**Figure 4 – Product Swirl from Installation Effect with Flow Conditioning**

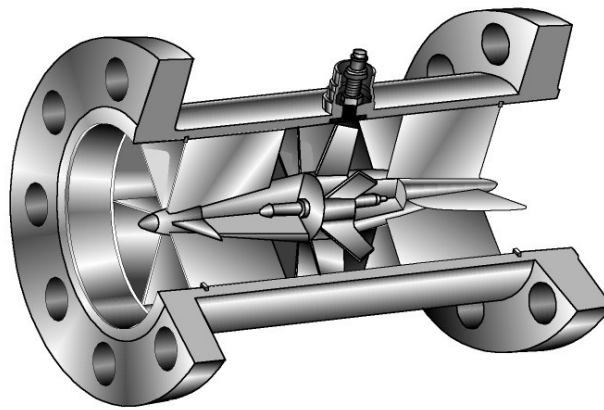
Profile distortions can negatively impact the quality of flow measurement. A flow conditioner can be used to mitigate and may be required to eliminate any flow profile distortions prior to the product entering certain meter technologies. Flow conditioners can eliminate the flow distortion in as little as 10 pipe diameters. For specific requirements the meter station piping should be modeled, and the flow conditioner manufacture should be consulted. Types of flow conditioners range from simple tube bundles (shown below) to high performance flow conditioners which address both swirl and velocity profiles.



**Figure 5 – Meter Tube with Strainer and Flow Conditioning**

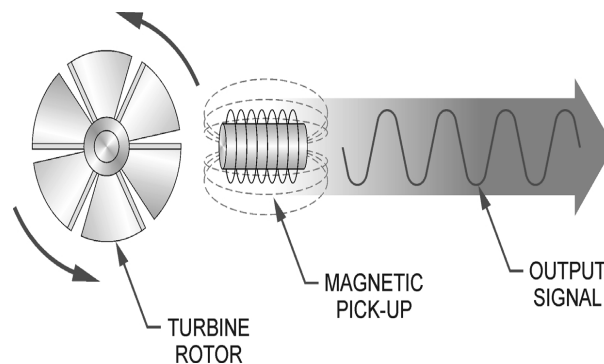
Meter technology must be considered to ensure the proper meter is selected and utilized on each installation. Currently there are two volumetric meters (turbine and PD) and one mass meter (Coriolis) commonly being utilized for NGL custody measurements. For volumetric measurement the Coriolis meter will be set-up to output volume pulses by internally converting the mass to volume output utilizing its measured density at operating conditions.

Turbine meters are mechanical meters that convert a fluid velocity into a rotational velocity. Any rotational velocity component in the product stream can affect a turbine meter, so flow conditioning should be installed as a good design practice.



**Figure 6 – Generic Turbine Meter**

Rotational velocity of the Turbine meter is measured by electronic pickups, and the electronic pulse outputs are sent a device to compile the pulses. Compiled pulses can then be converted to volume utilizing the K-factor for the meter installed. The unit of the K-factor is pulses / unit volume.



**Figure 7 – Schematic Illustration of Electronic Signal Generated by the Rotor Movement**

Since turbine meters are mechanical devices, the volumetric flow rate of the fluid must be maintained such that the force generated by the fluid is sufficiently large enough to minimize the effect of friction generated by the bearing. As long as the fluid flow rate is high enough, the meter's performance is relatively linear, but still non-linear enough to warrant a meter factor curve within the manufacturer's prescribed flow range (just not practical most of the time). As the fluid flow rate drops below the meter minimum, the effect from friction increase and the meter begins to under-measure; therefore, the meter manufacture should be consulted to verify the meter minimum prior to designing the station. Station design should ensure the flow rate is maintained above the meter minimum.

When the product changes on a given turbine meter, the viscosity and density can affect the rotational velocity of the meter. Any change to the rotational velocity of the turbine meter blades will directly impact the amount of product measured by the meter. Any time the product is changed on a turbine meter, the meter should be proved to generate a new meter factor (MF). Turbine meters require periodic proving to ensure the meter factor is consistent and that the meter is operating correctly. Any significant changes in the meter factor can indicate the meter is damaged or dirty.

Positive displacement (PD) meters are mechanical meters that rely on small, discrete volume pockets to measure the volumetric flow rate of the product passed through the meters. PD meters are highly repeatable, and work very well while operating in flow regions and viscosity that could be problematic with other meter technologies. Flow profile disturbances have very little effect on PD meters, so they work very well in installations with significant flow profile disturbances.

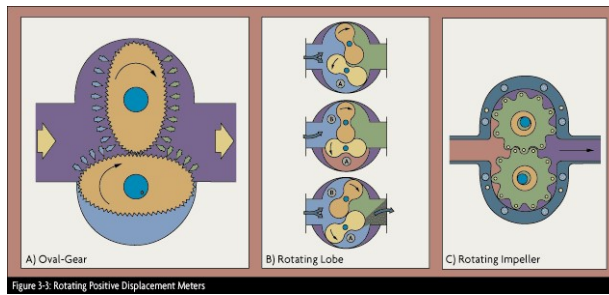


Figure 8 – Schematic of Typical Positive Displaced Meters

In certain applications PD meters work very well, but they can also have significant limitations. These meters require good filtration since they rely on tight clearances to maintain the seal between the volume pockets. As the seals degrade, so does the meter performance. Product slippage between pockets will result in the meter under-measuring. The tight seal tolerances and numerous moving parts also increase the likelihood of mechanical failure which leads to increased maintenance. For this reason, the fluid’s lubricity should be taken into consideration when PD meters are selected.

At higher flow rates installation of PD meters become problematic since the meters become large, heavy, and may require multiple meter runs as compared to other technologies. The higher cost of the PD meter often makes its installation less desirable when evaluating for larger flow rates.

Coriolis meters are non-mechanical and rely on the inertial force exerted on an object as a result of movement relative to a rotating frame of reference. In these meters, as flow passes through a vibrating tube, the tube begins to torque. The amount the tube torques is proportional to the amount of mass passing through the meter; therefore, the meter can be calibrated and setup to generate direct mass pulses out of the meter.

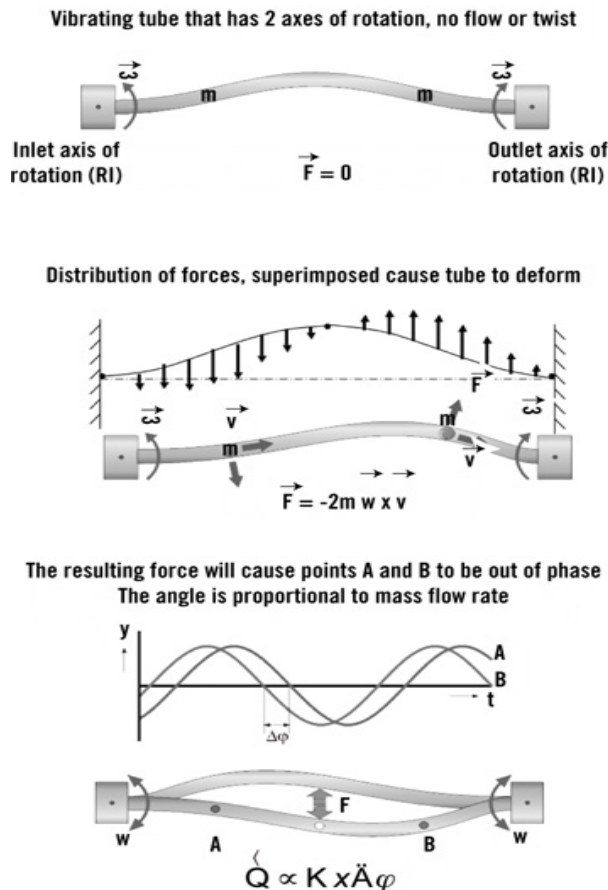


Figure 9 – Schematic of Coriolis Meter Guiding Principals

The meter also measures the period frequency of the fluid travelling within the tube. This frequency can be used to calculate the density of the fluid passing through the meter tubes. Since the mass and density are both known, the meter can be setup to generate a volume output. If setup for volume output, the meter can be proven volumetrically, but the density function of the meter must be verified since it is an integral part of the internal meter volume calculations. In this scenario the meter would function similarly to a volumetric meter.

Coriolis meters are very linear with very good accuracy when operated within acceptable flow ranges. As the flow rate decreases, the meter zero instability becomes a higher percentage of the overall flow rate causing the relative accuracy to deteriorate. Zero instability is the amount the meter fluctuates ( $\pm$ ) when the meter is blocked-in at operating conditions, and liquid full. Unlike the turbine meter, which always under-measures, a Coriolis meter can over-measure or under-measure. Care should be taken to ensure the meter station is properly designed to guarantee the meter is always flowing within its acceptable ranges for proper measurement.

Coriolis meters can be sensitive to vibration, and piping stresses, so the meter piping should be designed to confirm the meter is properly supported and care should be taken to minimize any vibrational concerns. Flow profile distortions have very little effects on Coriolis meters, so flow conditioning may not be a necessity.

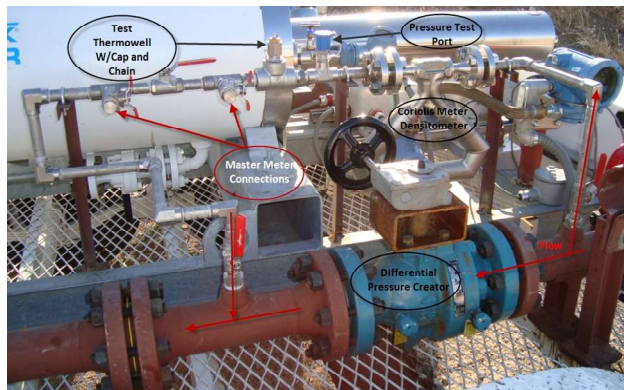
Coriolis meters require calculations be performed by the CPU in the meter transmitter which results in a measurement output delay. This delay results in a phase shift between the product measured by the Coriolis meter and the product moved through the prover. The phase shift between the two devices is the primary cause of the poor repeatability experienced by the meter during proving.

Volume products are sold at net conditions, but are measured at flowing conditions. Net conditions are defined as equilibrium vapor pressure (EVP) at 60°F or at 14.7 PSIA if EVP of the product is less than 1 atmosphere. To correct the product to net conditions, an accurate measurement of temperature and pressure is required. These process measurements are used to calculate the CTL and CPL from the API MPMS product tables. A spare thermowell is required to ensure the temperature transmitter is properly calibrated.

The product's temperature is required for CTL and CPL determinations. This is accomplished by two philosophies. The first is by using a fixed specific gravity at 60 which does not require a densitometer. The second is by using a live flowing density which does require a densitometer. From the flowing density along with the temperature and pressure, the flow computer uses an iterative procedure to back calculate the SG at 60

There are two primary types of densitometers which are currently being utilized. The first is an insertion type of densitometer. Insertion densitometers have velocity limitations which are commonly exceeded by the product velocities. In this case, the densitometers are installed in stilling wells off the mainline pipe. Stilling wells limit product velocities, but they also raise concerns about a representative sample being maintained in the stilling well. The installation of the stilling well also become problematic when verifying the instrument, since the operator must ensure the product contained in the calibration device (PYC Ball) is representative of the material within the stilling well.

The second densitometer type is a flow through densitometer in the form of a vibrating tube type densitometer or by utilizing the density function of a Coriolis meter. Scoops or quills should be utilized to make sure the sample is taken from the center third of the meter run piping. Depending on the scoop design utilized, the scoop should generate ample pressure to drive an adequate flow rate through the loop. It will be determined that an adequate flow rate has been established when the temperature at the densitometer outlet is maintained within 0.2°F of the flowing temperature of the fluid contained in the mainline pipe. If the scoop cannot generate adequate flow, then a device must be installed to force additional flow through the loop.

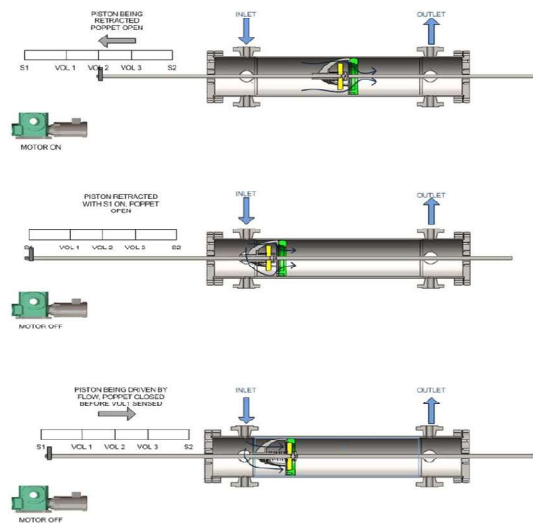


**Figure 10 – Picture of a Flow-through Densitometer Loop**

Facilities (Pyc ball connections) must be installed to verify the density measurement for both types of densitometers. During this density verification process, temperatures at the densitometer outlet, mainline pipe and pycnometer outlet must be within 0.2°F.

For custody measurement, provisions must be installed to prove each meter run independently. The decision should be made whether the meter will be proved with a portable prover or with a permanently installed prover. Frequency of provings, number of meters to be proved, and the location of the site are factors that must be considered when deciding whether to install a permanent prover.

A prover is a device calibrated to a known volume between a set of switches. Two commonly utilized types of provers are piston and ball provers. These devices are used to calibrate the meter by accumulating the pulses generated by the meter for the known volume of the prover. This volume moved through the prover is compared to the volume measured by the meter. A meter factor is created by dividing the prover volume by the measured volume. The meter factor is used to correct the actual volume measured to the known volume.



**Figure 11 – Typical Prover Operation**

The prover diverter must be a double block and bleed valve to ensure the valve is properly seated and no flow is by-passing the prover. By-passing flow will result in an improper meter factor being created and possibly implemented.

The piping to the prover should be minimized to ensure that the operating conditions within the prover are as close to the operating conditions of the meter. Keeping the operating condition as close as possible will minimize any proving errors due to CTL and CPL calculations. Caution should be taken when volumetrically proving Ethane and Y-grade, since the CTL and

CPL calculation for these products can be in error for certain process conditions. Decreasing the piping runs will also help to stabilize the system prior to initiating a prove.

A back pressure control valve should be installed on each meter run to guarantee the pressure of the meter run is maintained above  $1.25 * \text{Equilibrium Vapor Pressure (EVP)} + 2 * \text{Meter Delta P}$ . If this parameter is not maintained, then the liquid could partially vaporize causing mis-measurement, and the vapor could possibly cause damage to the meter itself. Damage could result from high velocities in the meter from two phased flow, or from cavitation within the meter.

### Inferred Mass Meter Station Design

Figure 12 below is a typical inferred mass measurement station design. Examples of mass products streams are: Y-grade, Ethane, E/P Mix, RGP, and RGB.

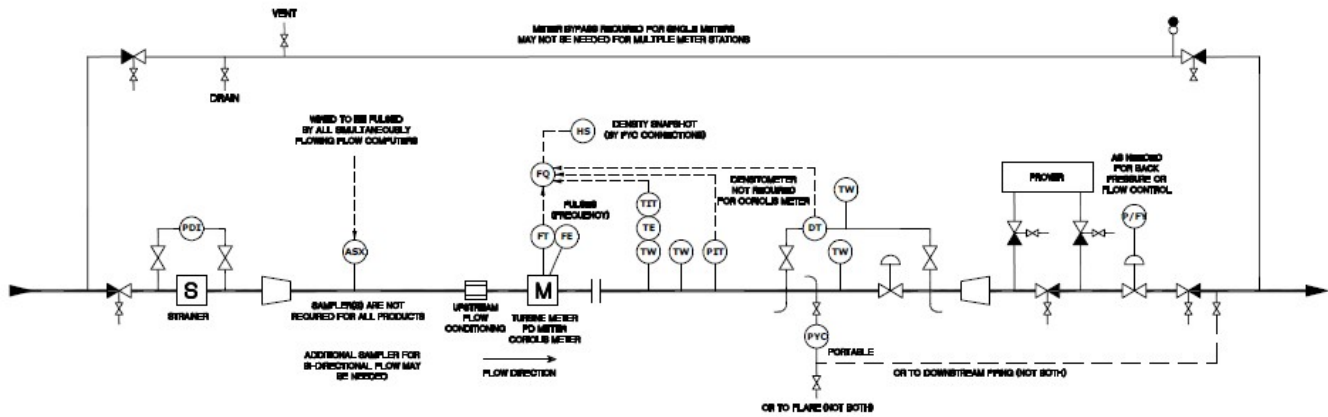


Figure 12 – Typical Inferred Mass Measurement Skid

The components required include: strainer, flow conditioner, meter, temperature transmitter, pressure transmitter, densitometer, sampler, prover, and a back pressure control valve. Only the components and requirements that differ from the volumetric meter station will be discussed.

All three meter types discussed can be used as a primary measurement device on an inferred mass measurement skid, but the meter must be coupled with an online densitometer. In the case of a Coriolis meter it can function as the meter and the densitometer, but consideration should be given to setting the meter and skid up for direct mass output. The indicated volume will be multiplied by the live flowing density as reported by the densitometer to calculate the mass flow rate. The same consideration given during the volumetric meter station design must be applied to this installation.

The primary difference on a mass system is the installation of a flow weighted composite sampler. A composite sampler is required to ensure the components within the stream are properly accounted. Errors related to composite samples and analysis can lead to component shifting issues which can have large financial impacts.

Composite samplers should be located as close to the piping as possible to minimize the sample volume contained in the quill, sample pump, and tubing between the meter piping and the accumulator. The size of this tubing should be relatively small to help minimize the volume of the sample contained within the tubing.



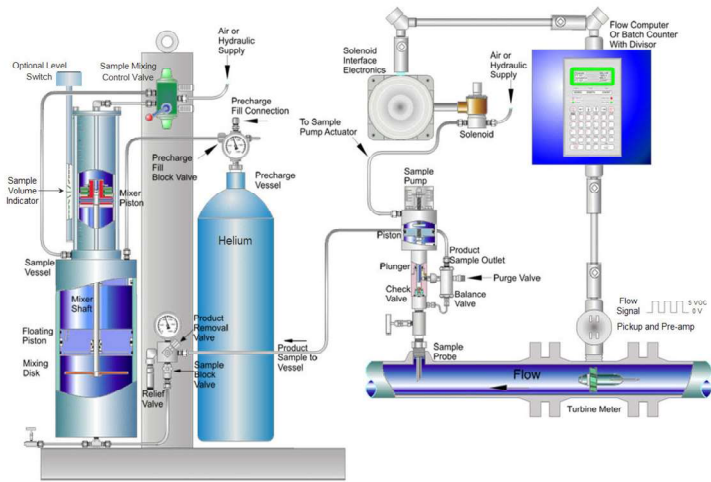


Figure 13 – Typical NGL Sampler Setup

The accumulator pots should be adequately large enough to accommodate the sample being collected, and the sampler pacing should be set such that the composite sample collected is representative of what flowed through the meter. In most instances smaller more frequent sample bite sizes are better than larger less frequent bite sizes.

To facilitate the collection and analysis of the sample per contracts, dual sampler systems may be required in some circumstances. Once the sample has been analyzed the analysis is applied to the totalized mass batch to get the component mass of the batch for accounting purposes.

### Direct Mass Meter Station Design

Figure 14 below is a typical mass measurement station design. Examples of a mass product stream are: Y-grade, Ethane, RGP, and RGB.

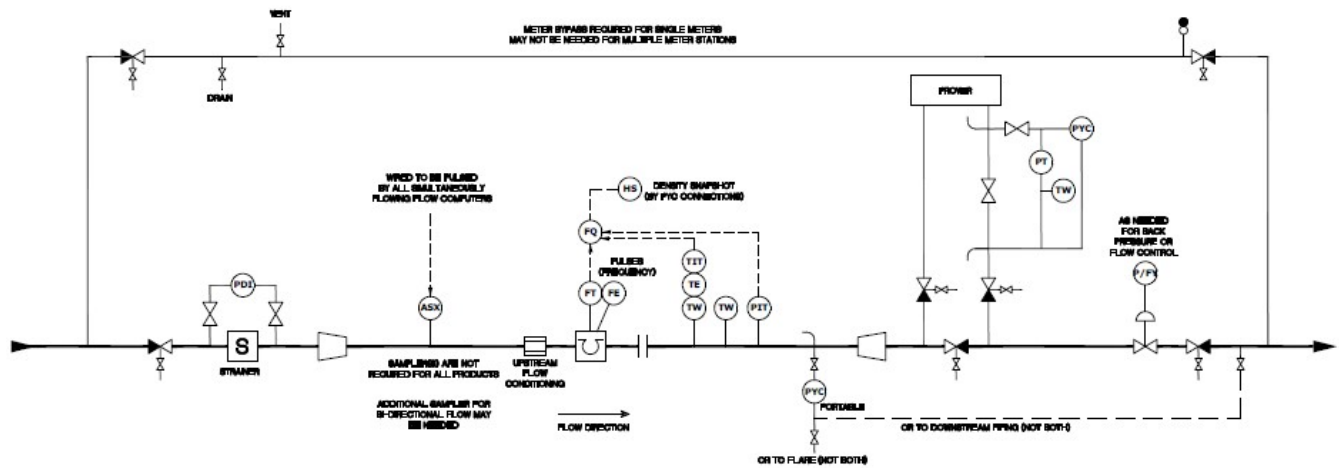


Figure 14 – Direct Mass Measurement Skid

The components required include: strainer, Coriolis meter, temperature transmitter, pressure transmitter, sampler, prover with densitometer, and a back pressure control valve. Only the components and requirements that differ from the inferred mass meter station will be discussed.

The first difference between an inferred mass meter skid and a direct mass meter skid is how the components are configured. The Coriolis meter and sampler must be configured to account for the mass output from the Coriolis meter. Configuring the

system ensures the Coriolis meter will report in mass, but the sampler can be paced via mass or net volume. Net volume will be calculated by converting mass to volume by utilizing the density function from the Coriolis meter.

Another difference is that the meter should be mass proved, so the densitometer must be set up to infer a mass for the prover. To generate an inferred mass for the prover the known prover volume must be multiplied by the average product density to generate an actual mass during the prove. Inferred mass measured by the prover is then divided by the mass as measured by the meter to calculate a mass Meter Factor. The densitometer should be installed on the prover outlet, and the same parameters apply that were previously mentioned.



**Figure 15 – Inferred Prover Installation**

Typical fluid velocities on meter run piping can be high in relationship to the prover piping, especially if the prover services multiple meters of differing sizes. If the meter being proved is small in relation to the prover sizing, the velocities in the prover piping could be significantly low, and would fail to generate adequate flow through the densitometer loop. Installation of a valve will ensure an adequate flow can be established through the loop by allowing the operator of the skid to create a temporary pressure drop within the system; thus, forcing additional product to flow through the loop. In this case installation of a valve should be considered.

### **Conclusion**

As outline in this paper there are three primary station designs, with the primary driving forces being: product to be measured, meter technology to be utilized for measurement, and any process design limitations.

While the stations all look similar and utilize common components, their arrangement and setups have subtle differences, so good engineering judgments should be a basic part of any design. Equipment manufacturers, and appropriate design standards should be consulted prior to any skid design to ensure the equipment is adequately sized for the process design parameters.