

FUNDAMENTALS OF MULTIPATH ULTRASONIC FLOW METERS FOR LIQUID MEASUREMENT

Dan Hackett

Emerson Automation Solutions
Daniel Flow Products
11100 Brittmoore Park
Drive Houston, TX USA

Introduction

The use of Liquid Ultrasonic Meters for liquid petroleum applications such as custody transfer or allocation measurement is gaining world wide acceptance by the Oil Industry. Ultrasonic technology is well established but the use of this technology for custody transfer and allocation measurement is relatively new. Often users try to employ the same measurement practices that apply to turbine technology to the Liquid Ultrasonic. There are some similarities such as: the need for flow conditioning, upstream and downstream piping requirements but there can also be differences such as the proving technique. This paper will discuss the basics of liquid ultrasonic meter operation and performance. While proving liquid ultrasonic meters is not specifically discussed, diagnostic information available to troubleshoot meter performance in general will be presented.

How Transit Time Ultrasonic Flow Meters Work

A Transit Time ultrasonic flow meter uses the transit times of the signal between two transducers to determine the velocity of a fluid. The transducer transmits ultrasonic pulses with the flow and against the flow to a corresponding receiver, as shown in figure 1. Each transducer will alternate as a transmitter and a receiver.

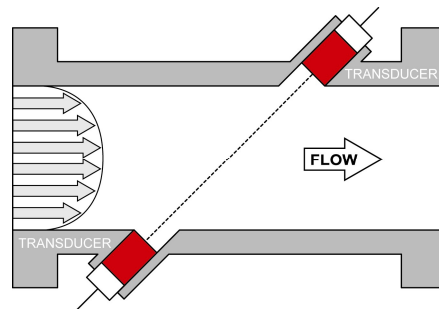

Figure 1: Transit Time Principle for Ultrasonic Flow Meters

Consider the case of fluid *stationary* in a full meter spool. In theory, it will take precisely the same time for a pulse to travel through the fluid in each direction since the speed of sound is constant within the fluid. If fluid is *flowing* through the pipe, then a pulse traveling with the flow traverses the pipe faster than the pulse traveling against the flow. The resulting time difference is proportional to the velocity of the fluid passing through the meter spool. Single and multiple acoustic paths can be used to measure fluid velocity. Multi-path meters tend to be more accurate since they collect velocity information in several points of the flow profile.

The transit time of an ultrasonic signal can be calculated. Although the ultrasonic signal is traveling in a straight line, it is traveling at an angle, θ , to the pipe axis, as shown in figure 2.

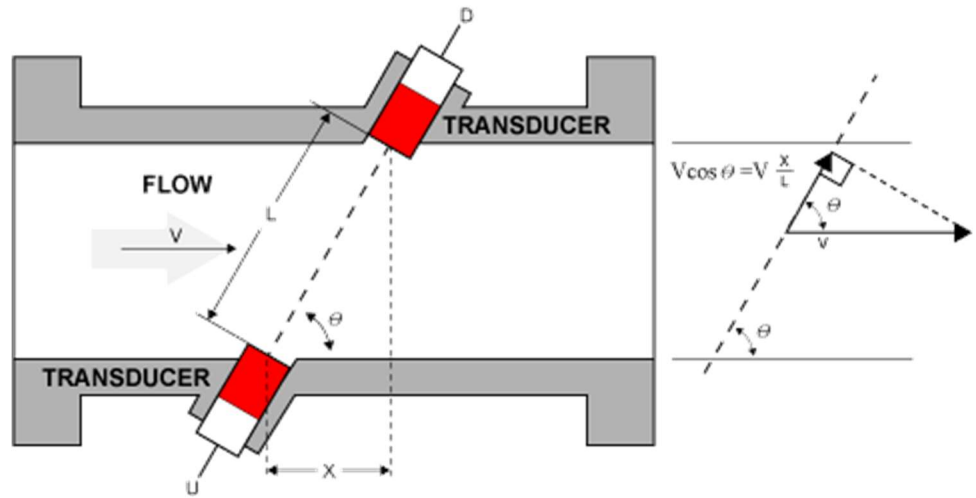

Figure 2: Variables for Calculating Transit Time

Equations 2 and 3 define the flow rate between two transducers located at positions U (upstream) and D (downstream):

$$t_{ud} = \frac{L}{C + V_i \cos \theta} \quad (2)$$

$$t_{du} = \frac{L}{C - V_i \cos \theta} \quad (3)$$

Solving equation 2 and 3 simultaneously yields the following results for V_i and C (Notice that x/L can be substituted for "cos θ " to simplify equation 4):

$$V_i = \frac{L}{2 \cos \theta} \cdot \frac{t_{du} - t_{ud}}{(t_{ud})(t_{du})} = \frac{L^2}{2x} \cdot \frac{t_{du} - t_{ud}}{(t_{ud})(t_{du})} \quad (4)$$

$$C = \frac{L}{2} \cdot \frac{t_{du} + t_{ud}}{(t_{ud})(t_{du})} \quad (5)$$

Where:

- t_{ud} = transit time from transducer U to D
- t_{du} = transit time from transducer D to U
- L = path-length between transducer faces U and D
- x = axial length between transducer faces
- C = velocity of sound in the liquid in still condition
- V_i = mean chord velocity of the flowing liquid
- θ = acoustic transmission angle

Since the equations are valid for fluid flowing in either direction, the unit is inherently bi-directional in operation. Also notice that the speed of sound term through the medium drops out of the velocity equation. Consequently,

velocity is determined from the transit times through the predetermined distances, and is independent of factors such as temperature, pressure and fluid composition.

Velocity Profile

The velocity profile of the fluid is very important to accurately measure the average flow velocity in a pipe. Ultrasonic meters measure the velocity of the fluid on discrete paths; they do not directly measure flow volume. The distribution of velocities across the flow conduit makes up the flow profile, as shown in the following figure for axisymmetric flow.

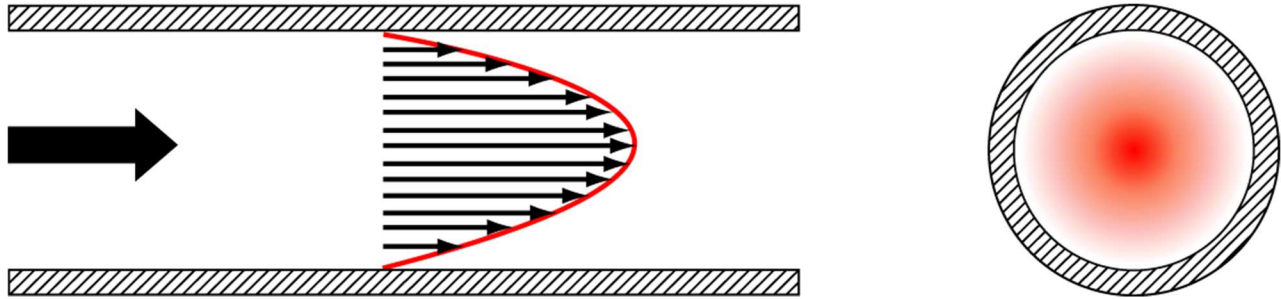

Figure 3: Flow Profile

Each of the arrows represents a different velocity in the flow profile. The longer the arrow, the faster the fluid travels in the conduit. The fluid contacting the inside of the pipe has no velocity. As the fluid nears the center of the pipe it increases in speed. The shape of the velocity profile changes according to several factors. These factors include:

- the fluid velocity, V
- the pipe size, D
- the pipe roughness, k
- the fluid viscosity, μ
- the fluid density, ρ

In the 1880's a British engineer named Osborne Reynolds studied these factors. He discovered that these factors can be arranged into the following equation.

$$Re = \frac{\rho \cdot V \cdot D}{\mu} \quad (5)$$

This dimensionless parameter, later called the Reynold's number (Re), is a criterion by which the flow regime may be determined in a smooth pipe. In a rough pipe, the following geometric parameter is used to determine the relative roughness in the pipe.

$$\frac{k}{D} \quad (6)$$

Increased pipe roughness results in greater friction loss and a change in the flow profile. The combination of these factors results in a fluid to flow in a laminar (smooth), turbulent, or intermittent manner.

Reynolds Experiment

In 1839 Osborne Reynolds demonstrated that the transition from laminar to turbulent flow occurs when a parameter we now call the Reynolds number exceeds a certain critical value. Reynolds connected a long glass tube to a water reservoir. He observed flow through the tube by introducing dye at the entrance of the tube. At low velocities the dye forms a thin straight thread parallel to the axis of the tube, indicating that flow is laminar (see Figure 4).

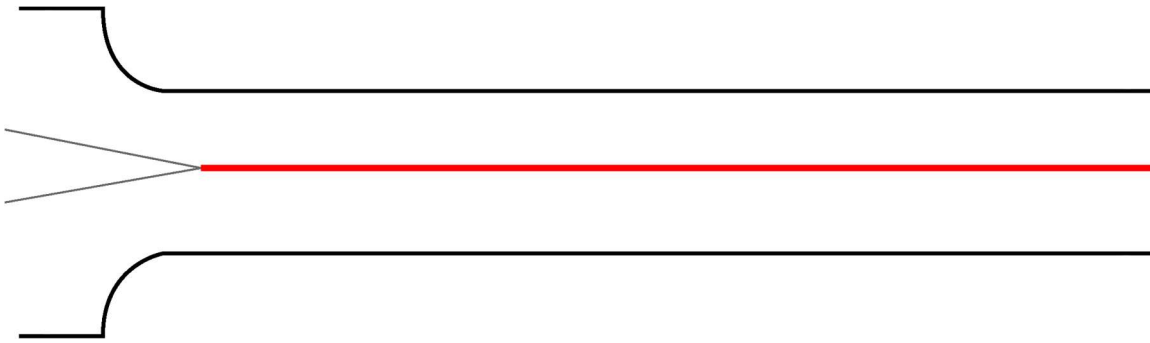

Figure 4: Laminar Flow

In laminar flow there is no visible mixing of adjacent fluid layers. A thin filament of dye injected into a laminar flow appears as a single line. If the velocity is increased, a critical point is reached where the nature of the flow suddenly changes in character. The thread becomes very agitated and the dye quickly spreads over the whole tube, indicating the flow has changed to turbulent (see Figure 5).

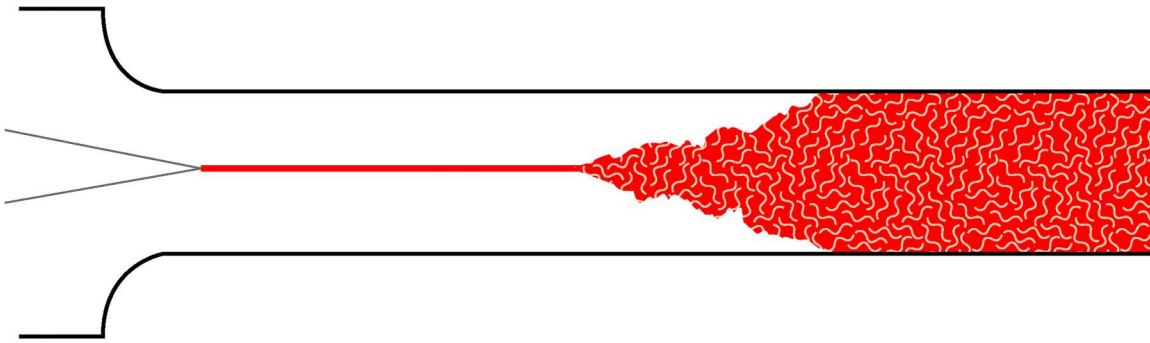

Figure 5: Turbulent Flow

In a long straight pipe, laminar flow exists as long as the Reynolds number is below a value of about 2000. At this stage the shape of the profile conforms to a parabola (see Figure 6).

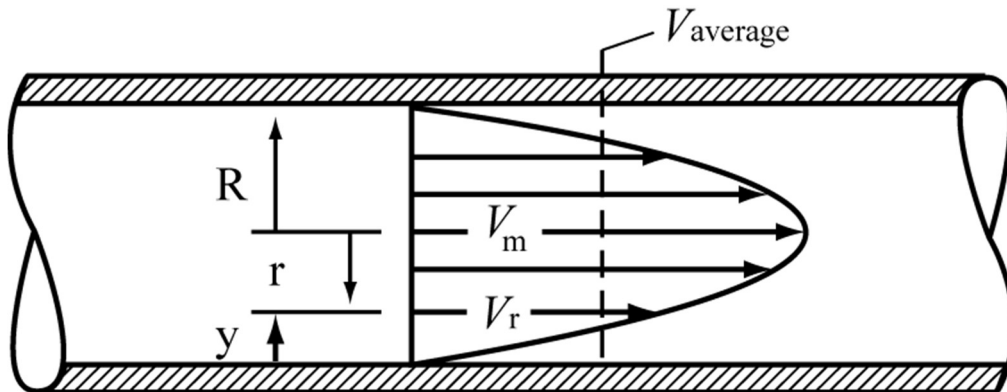

Figure 6: Laminar Flow Profile

The velocity of a point on the profile is given by Equation 7:

$$v_r = v_m \cdot \left[1 - \left(\frac{r}{R} \right)^2 \right] \quad (7)$$

where:

v_r = velocity at r

v_m = maximum velocity

y = distance from the pipe wall

r = radial distance from center

R = pipe radius

In laminar flow this analytical solution shows that the maximum flow is two times the average flow of the fluid.

When the Reynolds number exceeds 2000, flow becomes transitional then turbulent. It is no longer damped by the viscosity of the fluid. The turbulent flow profile appears more uniform than laminar flow due to mixing as shown in Figure 7:

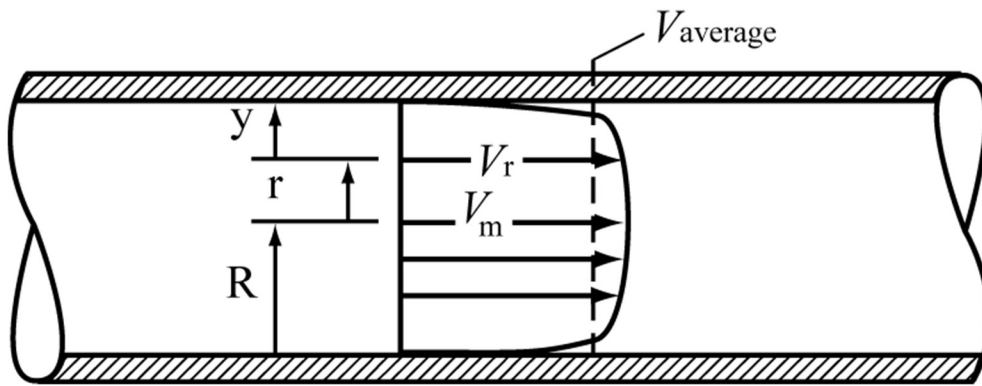

Figure 7: Turbulent Flow Profile

In turbulent flow the flow can be approximated by the Power Law shown in Equation 8:

$$\frac{v}{v_{\max}} = \left(\frac{y}{R} \right)^{1/n} \quad (8)$$

where:

n = an exponent dependent on the Reynolds number and surface roughness

It is called the Power Law because it is dependent on the value of the power exponent “ n ” in the equation. This simple power law provides a good approximation of velocity near the pipe wall, but not at the pipe center. In turbulent flow the maximum centerline velocity is approximately 1.2 times the average flow of the fluid, depending on the value of n .

Flow Disturbances

The flow profile in a pipe is impacted by bends, valves, headers, filters, or anything that impedes flow in the pipe. The disturbed flow profile is described by terms such as swirl, asymmetry, and cross flow (see Figure 8).

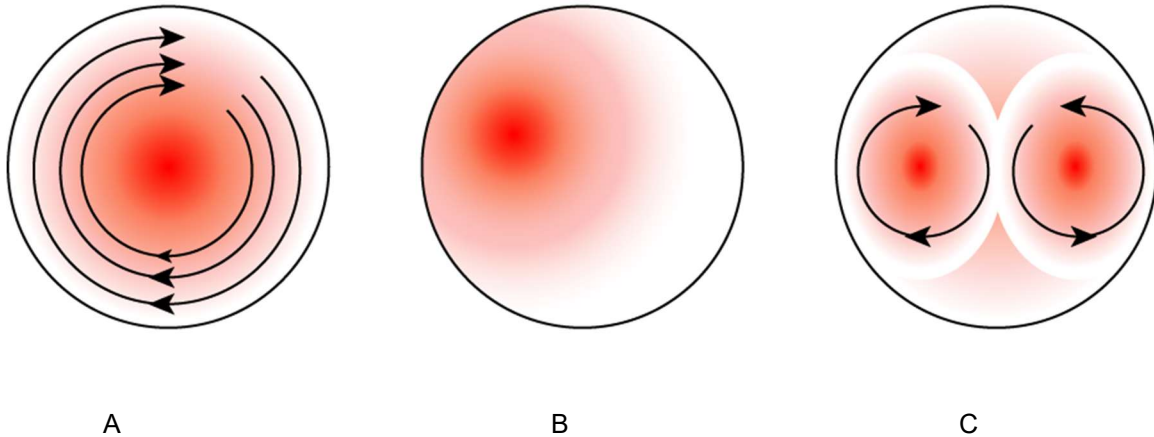

Figure 8: A) Swirl B) Asymmetry C) Crossflow

Swirl is a condition in which the fluid spirals inside the entire diameter of the pipe. It is most commonly caused by two bends in the pipe that are out of plane from each other. Asymmetry is a condition in which the maximum velocity is not on the centerline, and is often caused by a partially closed gate valve or obstruction in the line. Cross flow is a condition typically caused by flow passing around a bend in the pipe resulting in two vortices rotating toward each other. The use of a long, straight pipe helps to minimize these flow disturbances.

Calculating Flow Volume

Knowledge of the flow profile is necessary to compute an average fluid velocity. The average fluid velocity is difficult to determine since the flow velocity varies across the pipe. Multi-path ultrasonic flow meters apply a weighting factor (w_i) to each chord velocity (v_i) to account for the flow profile. The average velocity is calculated, as shown in Equation 9:

$$V_{average} = \sum_1^n w_i v_i \tag{9}$$

where:

- $V_{average}$ = average fluid velocity
- w_i = weighting factor
- v_i = chord velocity

Algorithm For A Chordal Multipath USM

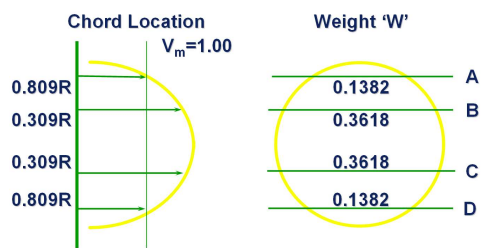

The flow volume through the meter is then calculated by multiplying the average fluid velocity by the cross sectional area of the pipe, as shown in Equation 10:

$$Q = V_{average} \cdot A \tag{10}$$

where:

- Q = volumetric flow rate
- $V_{average}$ = average fluid velocity
- A = pipe area

Since the cross-sectional area of the pipe can be measured very accurately, the biggest variable in the equation is the value for $V_{average}$. Multi-path meters, with the optimum number of paths, location of paths and weighting factors, require little correction to determine the average flow velocity.

Single path meters, on the other hand, require a correction factor. Single path meters that measure through the center of the pipe overestimate the average velocity by 4% to 9% in fully developed flow, if a correction factor is not applied. This overestimate results from the high velocity in the center of the pipe, where there is no area. By using a Reynolds number correction, this error can be reduced to about +/- 3%. The error remains since the Reynolds correction is based on fully developed flow, and can not account for flow disturbances.

Diagnostics

Turbine meters and Positive Displacement meters are mechanical devices with rotating or moving components. In a turbine meter the turbine wheel is set in the path of a fluid stream. The flowing fluid impinges on the turbine blades, imparting a force to the blade surface and setting the rotor in motion. When a steady rotation speed has been reached, the speed is proportional to fluid velocity. Positive displacement meters measure the volume or flow rate by dividing the liquid into fixed, metered volumes. These devices consist of a chamber that obstructs the liquid flow and a rotating or reciprocating mechanism that allows the passage of fixed-volume amounts. The number of parcels that pass through the chamber determines the liquid volume. The rate of revolution or reciprocation determines the flow rate.

Equipped with an electronic module to convert the mechanical rotation into a pulsed output, a problem with the performance of the meter is generally identified during proving operations by a shift in the meter factor. Ultrasonic meters are electronic with no moving components. All measurement starts with transit time determination and volumetric flow is calculated from the individual chord velocities as previously discussed. While a pulsed output is provided to integrate the ultrasonic meter with traditional flow computers as are turbine meters and positive displacement meters, significant additional diagnostic information is available to the user to continuously assess meter performance without having to rely solely on tracking meter factors established during proving operations.

Digital Signal Processing

The most fundamental element of meter performance is determination of the transit times. The detection of the received ultrasonic signal must find a consistent reliable zero crossing to use for the transit time measurement. The transmitted signal strength is limited by intrinsic safety considerations, so the received signal amplitude is a function of the acoustic impedance of the liquid, the meter size and the liquid velocity. An automatic gain control (AGC) is applied to the received signal to always achieve the same amplitude, to simplify detection. The value of the gain is a measure of the health of the transducer or attenuation in the path, and is a useful diagnostic.

As part of the signal detection many checks are made:

- The noise, found upstream of the signal
- The ratio of signal to noise
- The standard deviation of the transit times
- The signal quality, a measure of how quickly the signal rises
- A comparison between the transmitted and received signals
- A comparison between the upstream and downstream received signals
- A check for peak switching
- The tracking of a consistent zero crossing

If a signal does not pass all these tests it is not used for a transit time measurement and an alarm is given that is decoded to explain why the signal was rejected. This is a very useful diagnostic. The number of signals used in a batch is reported as Performance. A 100% performance is a sign that the meter is working well, and is the normally expected performance up to the full rated capacity of the meter. Anything less than 100% is another useful diagnostic.

With good transit time determinations ultimately yielding gross volume flow rate from the ultrasonic meter further diagnostic information is available to ascertain both the health of the meter and any flow dynamic effects that may impact the performance of the meter.

Meter Health Diagnostics

Typical information available indicating if the meter is working correctly

- Transducer Gains
- Signal Quality
- Signal to Noise Ratio
- Speed of Sound
- Velocity Profile
- Individual Chord Waveform

The velocity profile gives a fingerprint, detects asymmetry, swirl and cross flow, while the standard deviation of the velocity indicates turbulence (5 parameters). The SOS gives another fingerprint and gives four values from two different chord lengths that can detect temperature stratification (5 parameters). The digital signal processing (DSP) and automatic gain control (AGC) add a further 9 parameters for each of the eight transducers as described above. The waveform and spectra (frequency content) can be displayed, which is another 2 parameters. This gives a total of 21 potentially useful diagnostic parameters. If all 21 parameters are normal, then there is no doubt that the meter is working correctly. If the meter fails, there is sufficient information to diagnose and fix the problem. If there are problems with the flow metering system, and one has sufficient confidence that the meter is working correctly, it is then possible to look for other system problems. Typical system problems are swirl, turbulence, pulsations, and fluctuations.

These diagnostics are based on the chordal geometry of the meter (Figures 9 & 10).

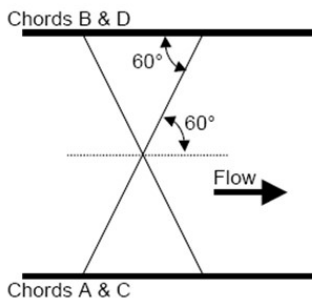

Figure 9

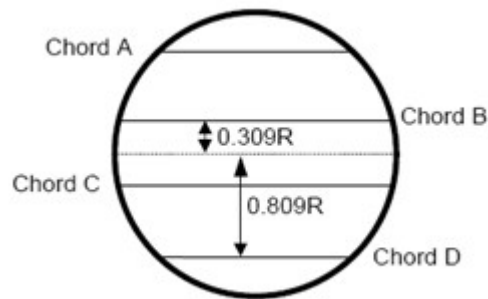

Figure 10

These parameters include:

- Profile Factor
- Symmetry
- Crossflow
- Turbulence

Profile factor is a fundamental indicator of meter dynamic performance.

It is the ratio of the sum of the inner chordal velocities over the sum of the outer chordal velocities. In a theoretically perfect meter this value would be 1.17. However, not all meters are theoretically perfect hence the value of establishing the profile factor during initial installation and proving and trending it is critical to monitoring performance of the flow meter.

$$profileFactor = \frac{V_B + V_C}{V_A + V_D}$$

Symmetry is the flow in the top half of the pipe compared to the flow in the bottom half of the pipe.

$$Symmetry = \frac{V_A + V_B}{V_C + V_D}$$

Crossflow is the comparison of chordal velocities crossing the flow right to left with those chordal velocities crossing the flow left to right.

$$CrossFlow = \frac{V_A + V_C}{V_B + V_D}$$

Perfect flow conditions will yield a symmetry and crossflow of 1.00. Turbulence is an indication of the velocity fluctuation derived from the standard deviation of the chordal velocities.

Identifying Dynamic Flow Disturbances

Well established flow yields a symmetrical flow profile. Individual chord velocities can be displayed as velocity ratios (the individual chord velocity divided by the average velocity). Graphically the velocity ratios present as symmetrical values. Using ratios allows the profile to be observed with consistent dimensionless values irrespective of absolute velocities (Figure 11).

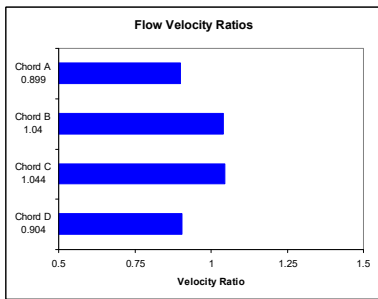

Figure 11

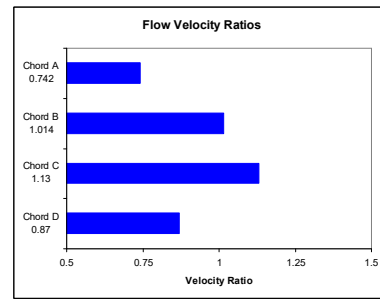

Figure 12

The velocity ratios moving over time can indicate a blockage upstream of the meter, likely in any flow conditioner being used. This change is generally sudden and pronounced as indicated in figure 12. A more gradual change which maintains symmetry but becomes more bullet shaped usually indicates dirt or wax build up in the upstream meter tube.

Swirl presents as an inverted flow profile and can be present on initial start-up due to upstream installation piping or can appear due to blockage in flow conditioners (Figure 13).

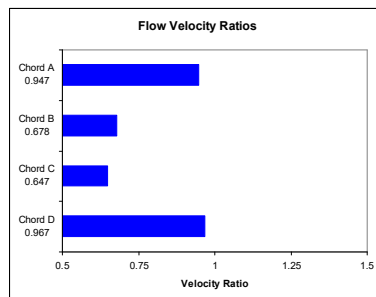

Figure 13

THE USE OF ULTRASONIC METERS FOR MEASURING LIQUID NATURAL GAS (LNG)

Current levels of uncertainty in LNG tanker custody transfer operations, combined with the increasing volumes being loaded, represent a significant financial risk.

Long-term LNG sale and purchase contracts restrict custody transfer operations to tank measurement technology that depends on minimizing various physical and operating variables in order to achieve acceptable discrepancies in the quantity of LNG transferred. In addition efforts to utilize proven ultrasonic flow meter technology as a dynamic alternative have limited its use to a general check meter, primarily because of the inability to validate its in-situ performance against industry standards and guidelines.

Finding viable options to reducing the current levels of fiscal risk by decreasing uncertainty is a challenging problem with a huge economic impact. The application of best practices for ultrasonic meter flow measurement systems to reduce overall uncertainty in LNG transfer quantities, combined with the latest LNG proving technology to ensure ongoing sustainable and reliable measurements, sets the foundation for acceptable check metering to manage and validate transfer discrepancies.

In international trading of LNG the quantity invoiced is the transferred LNG energy, given by the product of three quantities: volume, density and gross calorific value. The complex scheme used to calculate the energy value involves LNG sampling, the direct measurement of quantities and the calculation of derived quantities. The direct measurement of quantities, in turn, relies on the LNG tank level, composition and temperature while the calculation of derived quantities depends on the LNG volume inferred through the method known as 'tank strapping' as well as on LNG density and gross calorific value.

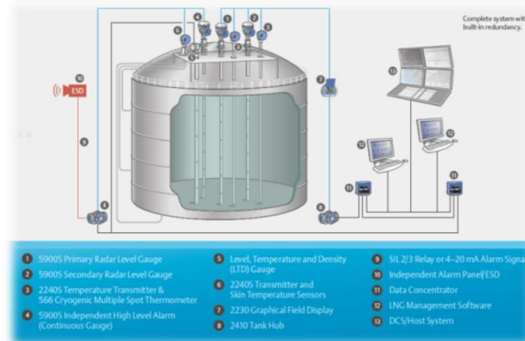

The implementation of these measurement methods and the derived quantity uncertainty are a major metrological challenge. The measurements need to take into account many different scenarios and parameters. These include variable tank shape, possibly involving deformation under the weight of LNG, errors in tank tables, surface conditions, cargo boil-off gas (BOG) rates and a cargo's equilibrium state. The method of quality determination also plays a very important role. The sample must be homogeneous and give an accurate composition of the LNG, as this has a direct influence on the calculated value of the density, calorific value and, therefore, transferred energy. Many differing gauge technologies are available for level measurement, each with specific advantages and disadvantages. It is therefore important to make the right selection based on the real operating conditions.

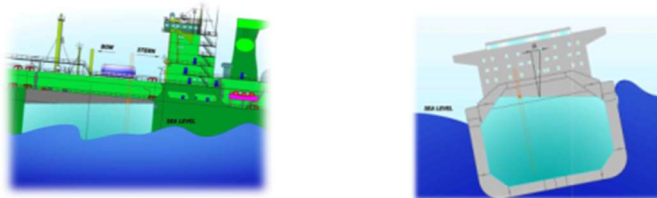

All these issues currently lead to a total energy measurement uncertainty for LNG that is higher than in typical oil or gas transactions. While the estimated best uncertainty value under ideal measurement conditions is 0.5 per cent, in normal operations this value can increase to 0.9-1.0 per cent or more. The impact is huge, considering that a 1

per cent uncertainty on the total value of the global LNG trade in 2010 (approximately 200 million tonnes) representing approximately US\$607 million.

Measurement techniques are being enhanced at a rapid pace. An alternative technology for LNG custody transfer applications exists today and is being employed as a volumetric check meter. Dynamic measurement of LNG with ultrasonic meters has already been accepted by the industry as a reliable solution that can provide improved accuracy.

The latest ultrasonic technology can overcome most of the LNG dynamic measurement problems, such as large drops in pressure and hot spots that could cause the liquid to gasify. These problems relate to the unstable nature of LNG, which is stored and transported at cryogenic temperatures close to its boiling point.

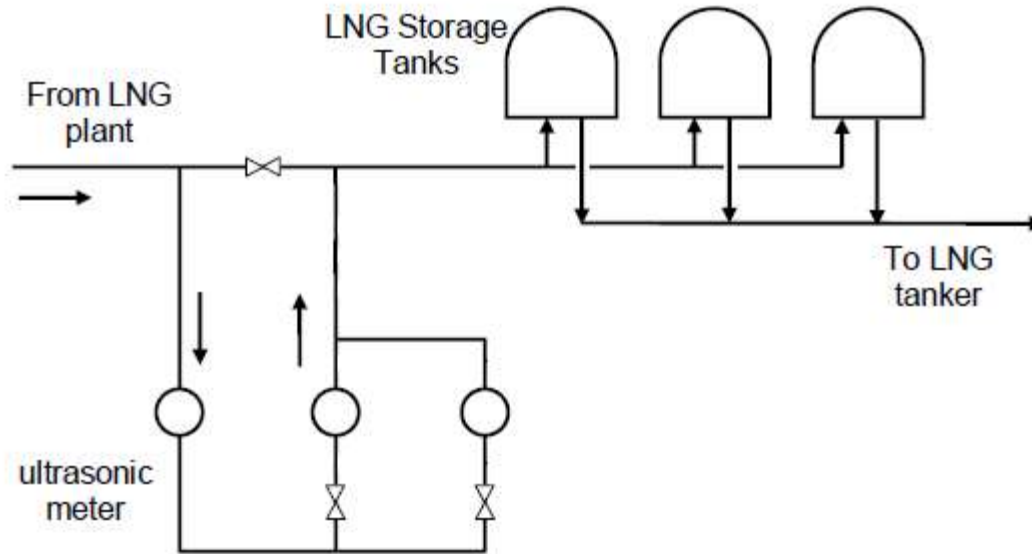

Ultrasonic meters allow mitigation of the sources of pressure drop in a metering system, as they are full bore devices and do not generate any incremental pressure drop beyond normal pipe friction. They are also generally sized to operate at relatively low velocities to keep the meter size the same as the pipe size. The electronics are remotely mounted to avoid a heat source close to the pipe and, consequently, reduce the hot spots. In addition meters are designed with integral insulation that facilitates installation of a user's primary insulation.

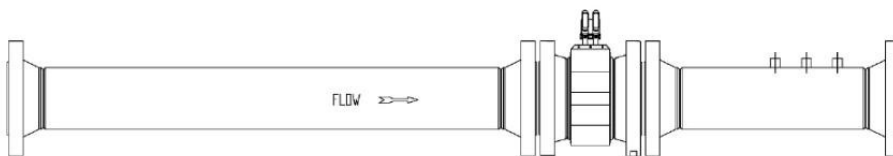

An additional challenge to the use of dynamic measurement has been the lack of an in-situ proving system for the meter. This requirement is fundamental in meeting industry standards and guidelines such as API Chapter 4. Bi-directional piston type provers have been used successfully for many years on a variety of fluids including liquid propane gas (LPG) but operating a prover at LNG cryogenic temperatures of approximately -162°C presents several challenges requiring new designs to main components such as flow tube and piston, proximity detectors, seals and a valve arrangement to perform the identical function as a traditional 4 way valve. These challenges have been met and today it is possible to provide a complete dynamic metering system complete with in-situ proving.

Conclusions

Liquid ultrasonic meters present certain advantages over conventional flow metering technologies with no moving parts and low pressure drop requiring no mechanical maintenance. A symmetrical non-disturbed flow profile is essential for proper meter performance and average velocity determination due to the chordal velocity sampling methodology employed.

Diagnostic information from the ultrasonic meter can be used with high confidence to both confirm meter operation and to identify flow dynamic disturbances which can impact meter uncertainty.

References

Klaus Zanker, Diagnostic Ability of the Daniel Four-Path Ultrasonic Flow Meter, 2nd SEAsia Hydrocarbon Flow Measurement Workshop, 2003

Dave Seiler and Peter Syrnyk, Field Proving of Custody Transfer Liquid Ultrasonic Meters, Hydrocarbon Processing, August 2007

Daniel Hackett, Maintaining Measurement Accuracy Using Gas Ultrasonic Flow Meter Diagnostics, 8th SEAsia Hydrocarbon Flow Measurement Workshop, 2009