

# FLUID FLOW CONDITIONING FOR METER ACCURACY AND REPEATABILITY

Danny Sawchuk

Canada Pipeline Accessories

Flow conditioning is one of the most critical aspects dealing with any type of volumetric flow metering. Flow conditioning is the final buffer between the flow meter and the upstream piping layout and is responsible for eliminating swirl, restoring flow symmetry and generating a repeatable, fully developed velocity flow profile. Even though modern advancements have resulted in low uncertainty, high repeatability devices that are effective across a range of flow rates, proper utilization of flow conditioner is still required to maximize the meters' performance, diagnostics and ensure the most stable long term flow measurement. All flow conditioner technologies are not made equal, as commonly used designs such as AGA tube bundles and straightening vanes can actually cause more measurement problems than they resolve. This paper will focus on two main types of flow conditioners; perforated plate systems and tube bundles.

Flow conditioner systems such as AGA-3 19 tube Bundles and straightening vanes have an extensive history of use in liquid and gas measurement systems over the past few decades. They are even being used in modern measurement scenarios that utilize ultrasonic flow metering. The common belief was that due to their length, straightening vanes were very effective at swirl removal, resulting in an excellent measurement device that offered a low pressure drop. Modern research has shown that this is quite the opposite. Their excessive length and low pressure loss makes them unsuitable for use in precision measurement applications, both in liquid and gas phase scenarios.

## Installation Effects

An installation effect is any object, fitting or obstruction in a pipe that leads to a fluid flow disturbance. This can be any valve, tee, orifice plate, eccentric orifice plate, pipe wall rust, misaligned gaskets or intruding probe that cause a distortion in the fluid flow. This can also be any series of piping direction changes (due to elbows, tees or headers) that result in a bulk fluid rotation (swirl).

## Flow Profiles

The key to studying flow conditioner performance is to understand the behaviour of velocity flow profiles. A velocity profile is a cutaway of the flow through the centre of the pipe. It shows the distribution of fluid velocity in a gas or liquid pipeline as you cross from one pipe wall to the other. A fully developed flow profile is the perfect, symmetric distribution of velocity from one pipe wall to the other. It is the natural state that all fluid flows return to over long distances of pipe due to the influence of the pipe wall friction. A deviation from this fully developed profile means that there are disturbances in the flow. Swirl will cause the velocity peaks to move closer to the walls due to centripetal force, while disturbances such as tees, elbows, valves, gaskets, probes will cause a distinct and unpredictable lack of symmetry. Good flow conditioners return the flow to the fully developed state in the shortest distance possible. Otherwise, at least 200 internal diameters of pipe may be required to fully ensure that no disturbances remain.

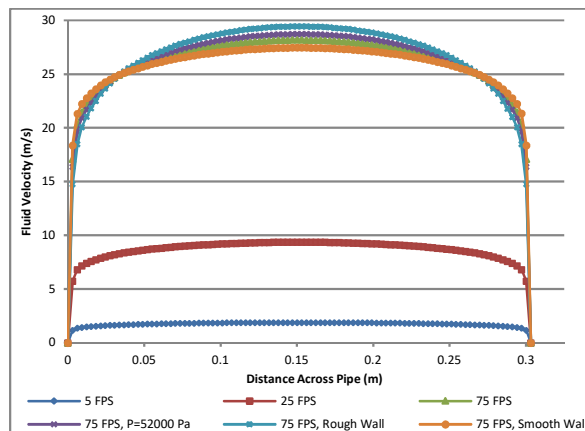

**Figure 1:** Fully developed velocity flow profiles in a pipe cross section. Distribution is from one pipe wall to the other through the center of the pipe.

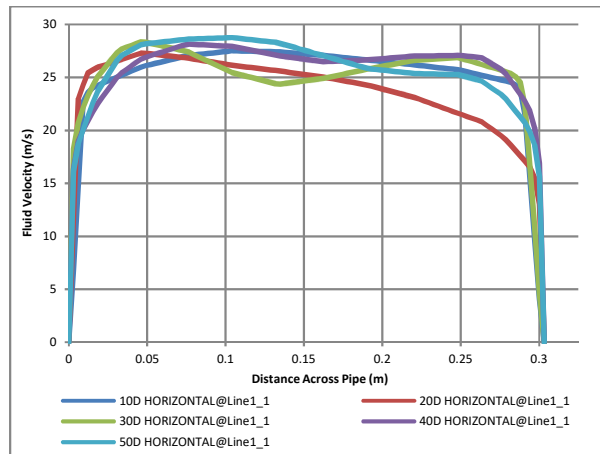

**Figure 2:** Example velocity flow profiles for non fully developed flow. Profiles shown are due to two elbows out of plane.

### Tube Bundle Performance Deficits

Straightening vanes and tube bundles are flow conditioning systems that are composed of vanes or small tubes welded together. Their openings are usually the same size and they can be roughly two pipe diameters long. It is commonly assumed that the length of a flow-conditioning device is directly linked to its effectiveness. Testing has actually proven this to be incorrect; the length of the flow conditioner actually causes more harm than good. To better understand this, the discrete behaviour of flow conditioners must be discussed.

There are three separate actions that a fluid flow undergoes when being flow conditioned. The initial pressure drop as the fluid is guided through the flow conditioner opening, the fluid travelling through the flow conditioner passages, and then fluid leaving the flow conditioner and returning to pipe flow conditions. The initial pressure drop forces the redistribution of fluid across the flow conditioner surface and will have the strongest impacts on the final velocity profile distribution of the fluid. If the flow conditioner has a low-pressure drop with holes that are equally sized, as in the case of a tube bundle, it will be unable to eliminate uneven velocity distribution in the pipe due to a distorted flow profile. The distorted distribution that enters the flow conditioner would be exactly the same distribution once it re-enters the pipe. A pressure drop is the first step to ensuring that the flow conditioner can effectively eliminate disturbances and a proper velocity distribution in the pipe.

The friction due to the wall roughness will act on the fluid and eventually restore the fully developed velocity flow profile if the pipe is long enough. This takes place in any pipe and does occur within the flow conditioners as well; the wall friction in each fluid passage acts on the fluid and attempts to form discrete flow profiles within the flow conditioner itself. As a result, the length of the flow conditioner will actually lock in the profile distortions due to discrete fully developed flow patterns occurring. The pressure drop due to the significant fluid/wall contact will also become a concern at lower viscosities. Pressure loss due to wall friction is typically not a concern in high-pressure natural gas applications (Reynolds numbers of approximately 5,000,000 to 30,000,000) but quickly become a problem when the fluid viscosity is increased.

Once the fluid leaves the flow conditioner, it then recombines into a total, bulk velocity profile. This is where the problems of the tube bundles become immediately evident as all the separate miniature flow paths recombine into one. Because of the low initial pressure drop, the volume, velocity and energy of the flow through each passage is not equal. When these flows recombine, they result in a single, highly distorted profile, as each passage is not contributing equally to the flow. This means that the tube bundle itself becomes an installation effect, just like a valve, tee or any other disturbance that results in a flow measurement error.

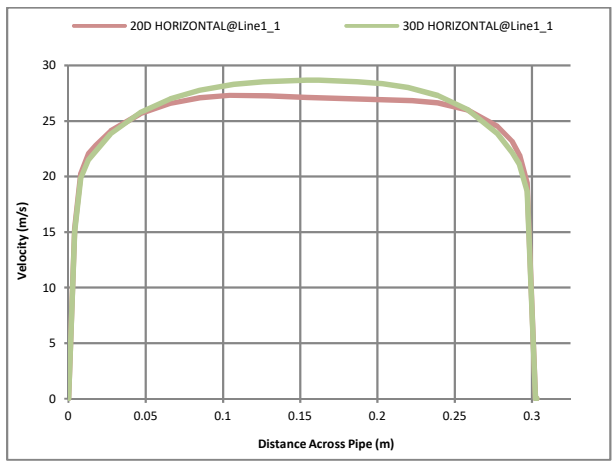

**Figure 3:** Tube bundle exposed to minor swirl. A 30D meter run is required to ensure fully developed flow.

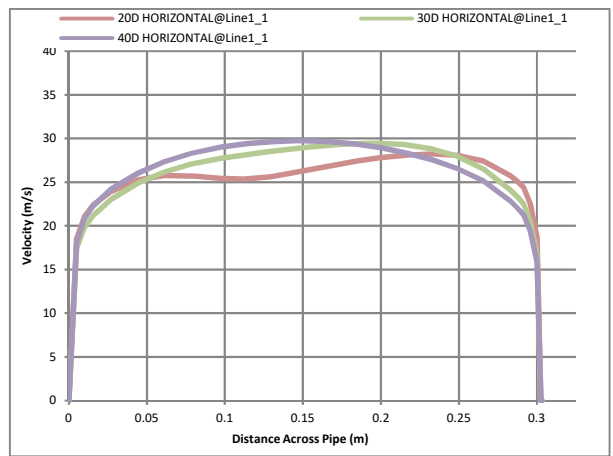

**Figure 4:** Tube bundle exposed to major swirl. A 40D meter run is required to ensure fully developed flow. A 20D meter run has a heavily inverted flow profile due to higher flow energy being stuck in outer tubes in bundle.

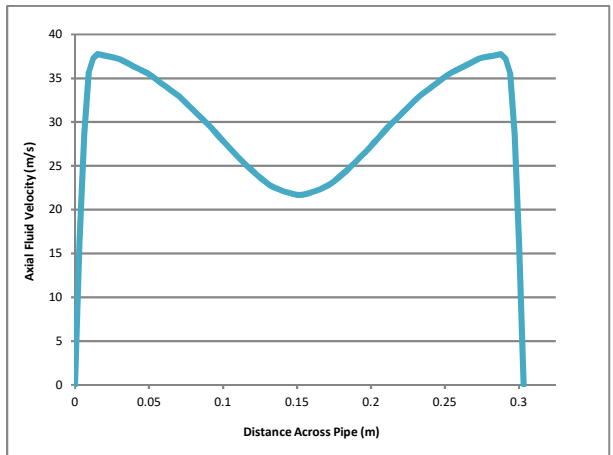

**Figure 5:** Tube bundle exposed to severe swirl (theoretical flow behaviour due to swirl generator). Using a 20D meter run, the flow profile is extremely inverted.

## Pipe Wall Friction

A fundamental of fluid dynamics and flow measurement is that pipe is a flow conditioner. Pipe wall friction and fluid viscosity are the most critical variables determining the shape of a fully developed flow profile in any gas or liquid pipeline. Flow profiles are generated by the pipeline wall drag. The fluid is pushing down the pipeline as quickly as possible and the wall friction is resisting this motion, creating the arc of a flow profile as the velocity is reduced near the pipe wall. The smoother the pipe wall, the flatter the profile, as the drag is reduced. Rougher pipe walls have pointier profiles due to the higher drag. Viscosity has the same effect on the flow profile shape. Higher viscosity fluids have a greater resistance to flow and result in more wall drag and a peaky flow profile, while lower viscosity fluids result in less drag and a flatter profile. This means that higher viscosity flows or rougher pipes restore their fully developed flow profile much more quickly than lower viscosity flows or smoother pipes. The increased pipe wall drag due to the viscosity and wall roughness is dragging the flow back into a fully developed state while also eliminating swirl.

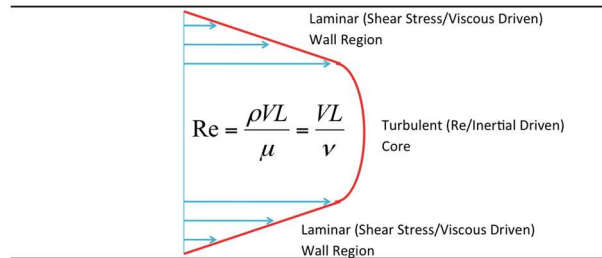

**Figure 6:** Formation of a fully developed flow profile due to the influence of wall friction.

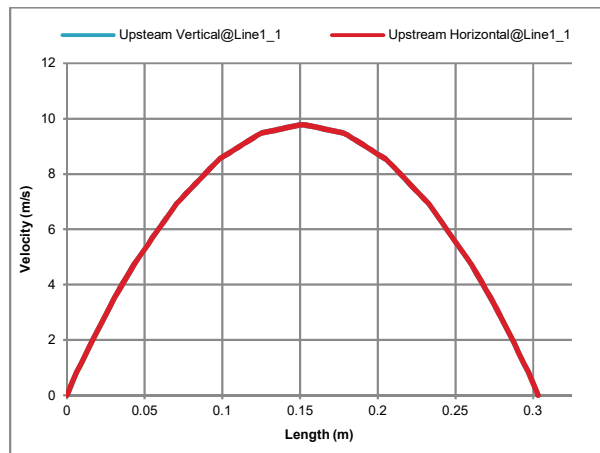

**Figure 7:** Fully developed flow profiles in a laminar flow,  $Re \sim 800$ .

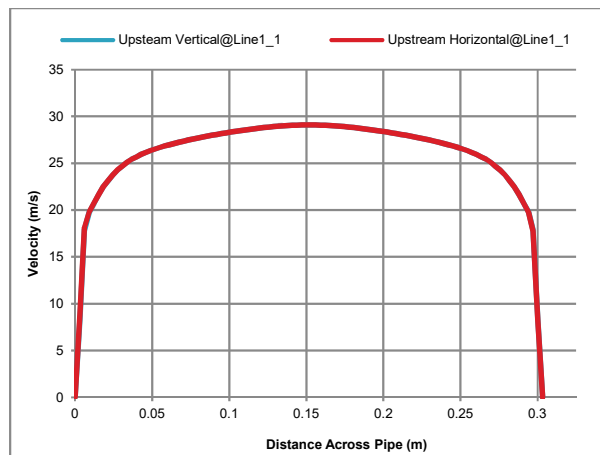

**Figure 8:** Fully developed flow profiles in a turbulent flow,  $Re \sim 30,000,000$ .

## Perforated Plate Flow Conditioning

A perforated plate flow conditioner is a solid metal disk with a carefully designed hole pattern. They are typically only a few inches thick. They are effective for three reasons: a tested hole layout, a abrupt aggressive pressure drop and the short length. The hole layout is designed to result in a effective redistribution of the fluid flow. This helps balance the fluid so that it can more quickly reach the fully developed flow profile distribution. The pressure drop helps properly balance the fluid flow across the flow conditioner and ensure that each hole moves the amount of fluid that it was designed for. This step removes any flow distortions or asymmetry. The fluid is also accelerated through the holes in the plate; this acts as a filter and removes the rotational vector from the swirl. The short length ensures that the fluid doesn't have time to redevelop flow profiles within the flow conditioner itself. The symmetrical, swirl free flow leaves the flow conditioner at which point it recombines into a bulk, swirl free, fully developed flow profile after 5 – 8 internal pipe diameters.

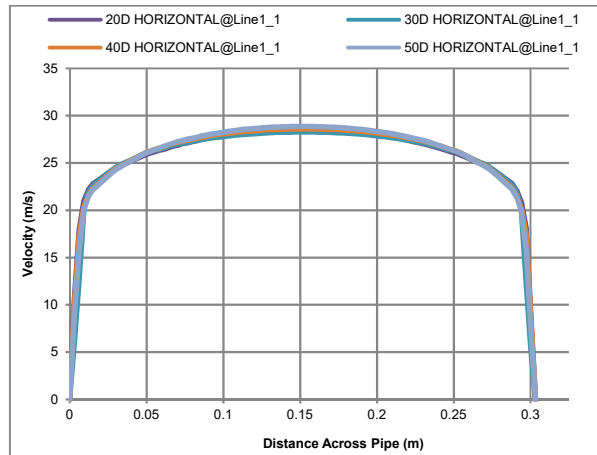

Figure 9: Flow profiles downstream of a perforated plate flow conditioner with straight pipe upstream.

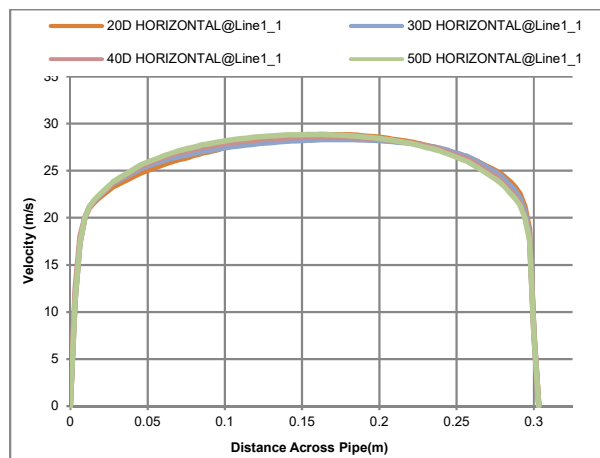
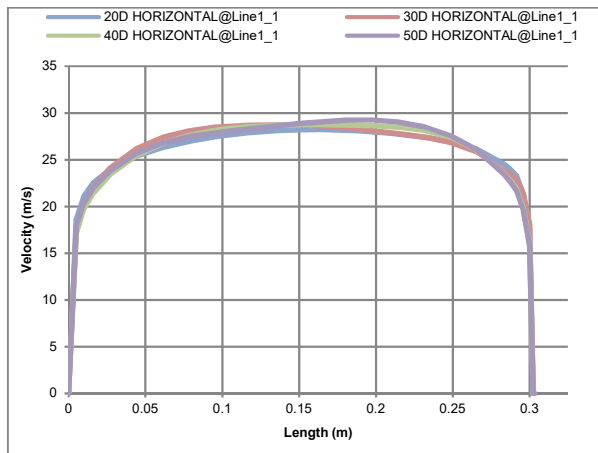

Figure 10: Flow profiles downstream of a perforated plate flow conditioner with elbows upstream.



**Figure 11:** Flow profiles downstream of a perforated plate flow conditioner with tees upstream.

### Orifice Meters & Differential Pressure Measurement

An orifice meter is a very simple type of meter. The flow is forced through an obstruction known as the primary element and the fluid pressure before and after is measured. The square root of the difference in this pressure is approximately proportional to the mass flow rate and velocity of the fluid. This behaviour is applicable to all types of differential pressure measurement; venturi meters, cone meters, wedge meters and multi hole orifice plates for example. The fundamentals for each type are the same but the specifics of tap location and primary element shape determine the rangeability of the flow meter, permanent pressure recovery and resistance to errors caused by flow distortions.

Due to the limited source of input information, orifice meters can be very sensitive to velocity profile distortions and swirl. Lower beta ratio orifice installations are less sensitive to velocity profile distortions as the increased pressure drop of the orifice plate helps act as a flow conditioner and results in a better-averaged state of the flow profile. The fundamental problem with dP measurement is that all data is typically being retrieved from a single pair of pressure taps. This reduces the amount of information available and makes the meter very sensitive to local pressure effects based on the physical location of the taps.

Swirl is one of the primary concerns when dealing with orifice meters and dP measurement for a variety of reasons. First, the rotational velocity component of the swirl causes a measurement error as the increased velocity directly over the pressure taps results in a local reduction in measured pressure that does not correspond to the overall bulk pressure behaviour. Second, in severe swirl instances, the centripetal force of the fluid pushes the fluid energy to the pipe wall, resulting in a deviation from fully developed energy distribution. Third, the interaction of the swirl with the measurement primary element itself can cause unpredictable fluid dynamic behaviour. Severe pressure drops force the swirl to behave in unexpected ways, further complicating the flow measurement.

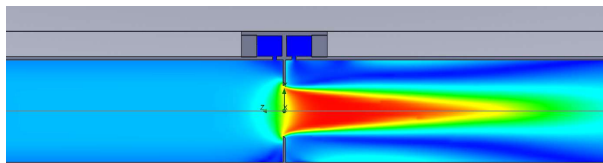

**Figure 12:** Visualization of velocity contours as flow passes through an orifice meter.

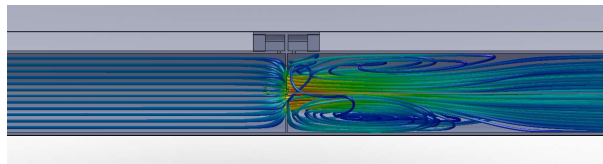

**Figure 13:** Visualization of velocity trajectories as flow passes through an orifice meter.

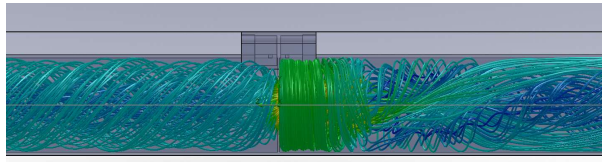

**Figure 14:** Visualization of velocity trajectories as flow with heavy swirl passes through an orifice meter.

Velocity (fps)	Velocity (m/s)	Swirl (Degrees)	P1 (kPa)	P2 (kPa)	Density ( $\rho$ )	K	deltaP (kPa)
50	15.24	0	5598181	5458170	36.84	32.73	140011
50	15.24	20	5591067	5471339	36.74	28.06	119728
50	15.24	45	5560318	5497955	36.68	14.64	62363

**Figure 15:** Showing how the addition of swirl can change the output of an orifice meter due to the local effects of the velocity at the pressure taps.

## Ultrasonic Meters

Ultrasonic Meters (USM) function by bouncing an ultrasonic sound pulse from one side of the pipe to the other. This is done along a predetermined path, and then repeated on the reverse of the path. The path is at an angle so the pulse will either be travelling with or against the axial bulk velocity flow. The time for the sound pulse to travel from one side of the pipe to the other is then measured. As one path is being carried with the bulk fluid flow, it'll have a lower transit time across the pipe, where the path that is opposing the fluid flow will have a higher transit time. The difference in these times is used to calculate the average velocity measured across that transit path.

Problems exist, as the only variable that an ultrasonic meter is able to consider is this transit time. There are no other inputs that it is able to analyze. This means that the velocity flow profile that the path is measuring has to be assumed to be symmetrical and evenly distributed across the pipe. The USM path has no way to determine what the distribution of velocity is in the pipe. This causes issues when dealing with swirl. A single USM path has no way to distinguish if the velocity influencing its travel time is due to the axial bulk velocity or a transverse component due to swirl.

To combat this, modern Ultrasonic Meters are built with multiple signal paths. These are positioned at different distances across the pipe to help generate an overall picture of the pipe flow by combining the results from each path. These positions are chosen based on selecting areas of the pipe where a majority of the flow volume and swirl may be found to make sure the meter is accessing as much critical flow information as possible. They may also be in locations that are isolated from shifts in Reynolds numbers to help reduce meter error due to changes in pressure or viscosity. The paths may also be oriented in different planes to help combat swirl or any issues that would generate transverse velocities across the pipe.

The data from these paths is combined to generate a complete picture of what is occurring in the flow. Based on an understanding of the shape of the velocity flow profile at the path location, each path can be properly weighted for its contribution to the final average calculation of flow velocity. Each signal path is essentially one slice of the final velocity profile vehicle. The more slices available, the higher the resolution of the final picture. The below figures help illustrate this relationship. Figure 16 shows the average velocity profile that is present at the center of a sample flowing pipe, while Figure 17 shows the profiles that a two path Ultrasonic Meter would see at this same location. Once we do a weighting correction to adjust the outputted values due to their location, we find that USM Path 1 varies from the bulk velocity flow by -5.99% while USM Path 2 varies by 7.62%. Taking the path at the center of the pipe only results in a 1.2% deviation. The problem is that if we cannot observe the state of the flow profiles and we do not know what the actual bulk mass flow rate and velocity is for this corresponding pipe flow, how do we know which of these profiles is the correct representation of what is actually occurring in the pipe?

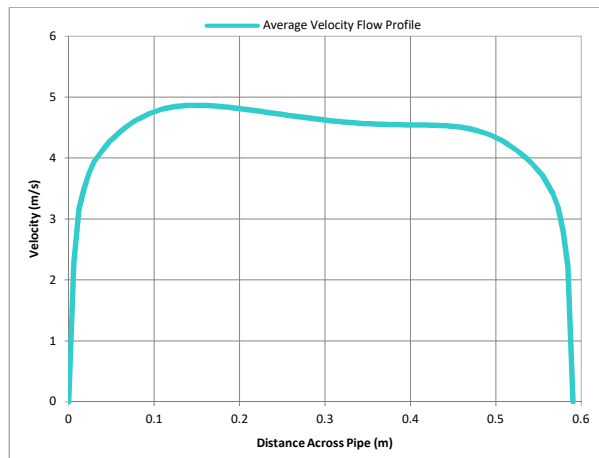

**Figure 16:** Average velocity profile at USM location, taken from center of pipe.

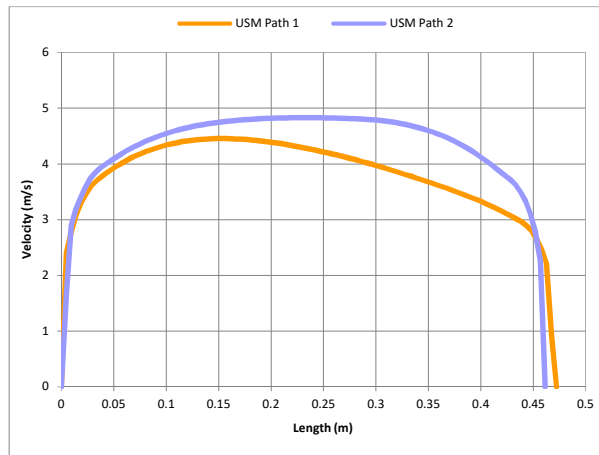

**Figure 17:** Velocity flow profiles for a theoretical two path Ultrasonic Meter.

## Liquids and Pressure Drop

Tube bundles still see use in modern applications due to the assumption that perforated plate flow conditioners should not be used in liquids. This is because most modern flow conditioning systems are developed using natural gas test labs for convenience and financial feasibility. Flow conditioner behaviour in gas is immediately transferable to liquids due to the fact that the only functional difference is in the viscosity, molecular composition and density of the fluid. Fluid phase is only a concern when dealing with thermodynamics, heat capacity and enthalpy of a fluid. Fluid dynamics and flow measurement are only concerned with Reynolds number and viscosity. As a result, as long as the fluid is single phase (multiphase measurement in general is a very complex and problematic concept) it will always behave the same, independent of whether it's a gas or liquid, oil, water, air or natural gas. Pressure loss due to piping and flow conditioners will change but this is simply due to the different densities and viscosities being used. As a result, properly designed flow conditioners can be used in all fluid types, not just natural gas.



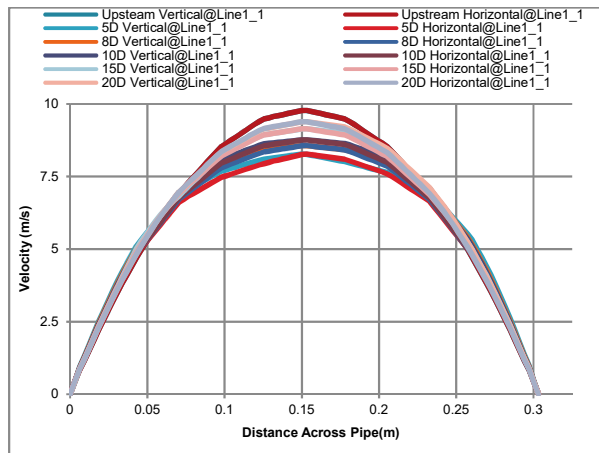

Figure 18: Fully developed flow profiles downstream of a perforated plate flow conditioner in laminar flow,  $Re \sim 800$ .

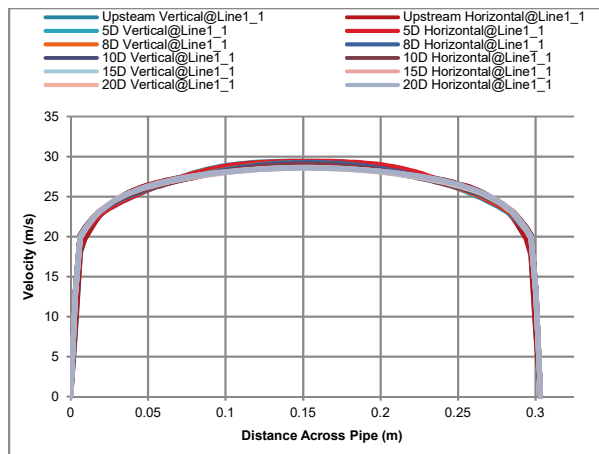

Figure 19: Fully developed flow profiles downstream of a perforated plate flow conditioner in turbulent flow,  $Re \sim 30,000,000$ .

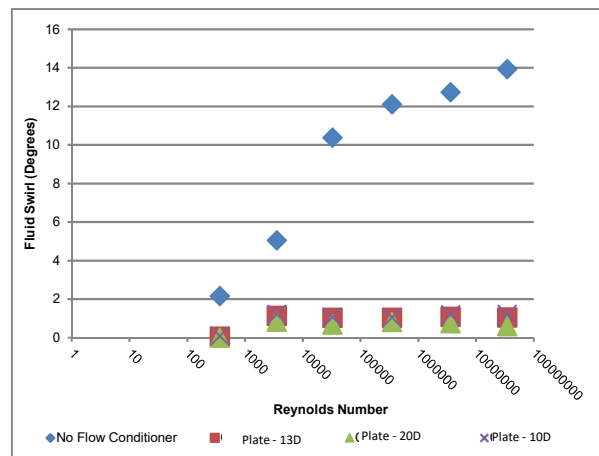

Figure 20: Showing the effectiveness of a plate based flow conditioner at eliminating swirl across a range of Reynolds numbers.

Tube bundle use in liquids has also been more predominant due to misunderstandings of the pressure drop effects across a range of Reynolds numbers. It is typically accepted that the pressure loss coefficient of straightening vanes and tube bundles is roughly 0.75 – 1.25. This is roughly half of the commonly accepted pressure loss coefficients that are used for perforated plate flow conditioners, which is commonly found to be around 2.0.

The problem with these values is that the pressure loss coefficients have to be determined from experimental testing. Most of the lab work that was done to study these values was done in high-pressure natural gas; a high Reynolds number, low viscosity application. The resultant data was then extrapolated to not only cover the entire turbulent range of fluids, but the

laminar region as well. This is incorrect as changing the Reynolds number, and specifically the viscosity can have extremely significantly effects on the pressure loss coefficient and the pressure drop.

The other problem is the assumption that because a tube bundle has a higher open area than a perforated plate flow conditioner, it must have a lower pressure drop. This is only partially correct.

	19-Tube Bundle			Perforated Plate
Wall Thickness (Inches)	0.125	0.250	0.298	
Pipe Diameter (Inches)	11.938	11.938	11.938	11.938
Pipe Area (Inches <sup>2</sup> )	111.932	111.932	111.932	111.932
Flow Area (Inches <sup>2</sup> )	94.957	79.848	74.493	53.450
Porosity (%)	84.84%	71.34%	66.55%	47.75%

Figure 21: Showing the difference in open flow area in various AGA-3 19 tube bundles and a perforated plate flow conditioner.

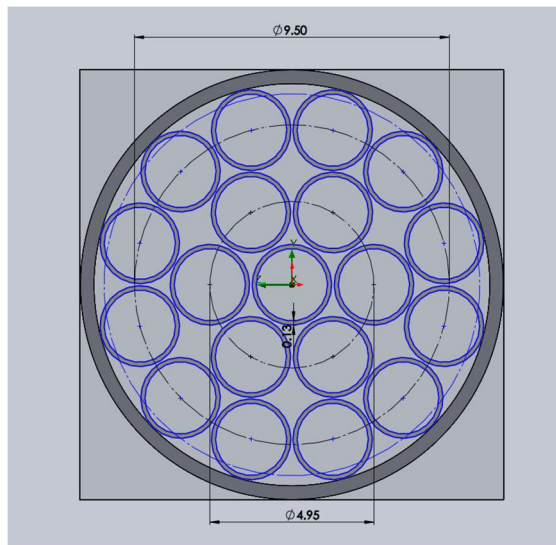

Figure 22: A CAD cutaway of an AGA3 19 tube bundle, illustrating the open flow area.

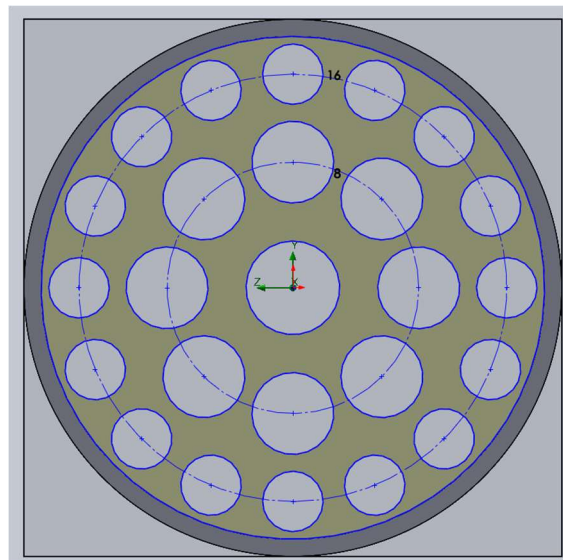

Figure 23: A CAD cutaway of a perforated plate flow conditioner, illustrating the open flow area.

	19-Tube Bundle	Perforated Plate
Wall Thickness (Inches)	0.250	
Pipe Diameter (Inches)	11.938	11.938
Pipe Area (Inches <sup>2</sup> )	111.932	111.932
Flow Area (Inches <sup>2</sup> )	79.848	53.450
Porosity (%)	71.34%	47.75%
Published K Factor Per ISO 5167	0.75	2
CFD K Factor, Re 30,000,000	1.39	2.020

Figure 24: Illustrating the different pressure drop characteristics of a 19 tube bundle vs a perforated plate flow conditioner.

The lower flow area accounts for a lower pressure drop in fluids with extremely low viscosity. This is because the wall friction becomes a negligible portion of the overall pressure drop. In fluids with higher viscosities, it cannot be ignored.

$$h_{friction} = f \frac{LV^2}{d2g}$$

Figure 25: The relationship between piping friction losses, duct diameter, duct length and fluid/pipe friction factor.

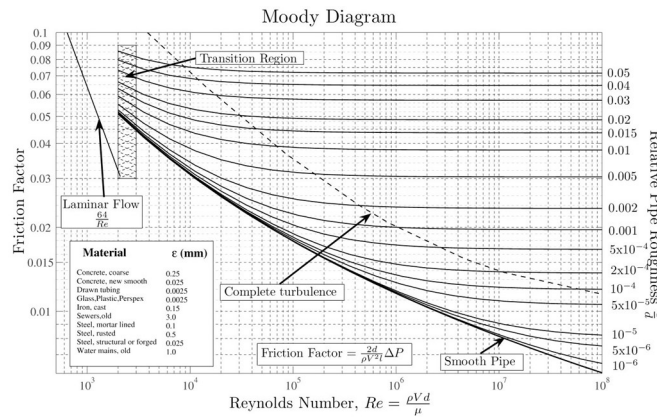

Figure 26: The Moody Diagram, used for calculating friction factor using Reynolds Number and the pipe wall roughness.

The pressure losses due to wall friction can be calculated using the  $h_{friction}$  equation. This equates the pressure head loss as a function of the pipe friction factor. Friction factor is calculated using the moody diagram and the Reynolds number of the flow. Reynolds number takes into account the density, velocity and viscosity of the flow. Changing the viscosity will have the largest effect on the Reynolds number as difference in viscosity values between different fluids can change by orders of magnitude.

The moody diagram shows that as the Reynolds number is decreased due to increasing the viscosity, the friction factor also increases. Once the fluid reaches the laminar regime, the friction factor suddenly increases even more quickly.

The calculation of head loss due to friction primarily deals with closed ducts of a fixed diameter and length. This becomes an issue when dealing with flow conditioners. Due to the construction of the tube bundle, they have significantly a higher surface area than perforated plates; the flow is passing over both the inside and the outside surfaces of the tubes. If we consider per unit length (1’), a perforated plate flow conditioner has a surface area of roughly 128 square inches, while an AGA3 19 tube bundle has a surface area of roughly 287 inches.

This problem is compounded by the fact that tube bundles are significantly longer than plate style flow conditioners. This was so that the device could compensate for the reduced flow conditioning effectiveness from the lower pressure drop. Typical plate based flow conditioners have a thickness that is only 10 – 20% of the pipe inside diameter. Tube bundles are two to three times the pipe inside diameter. As a result, this gives tube bundles an additional 20 – 30 times increase in the wetted flow area. In scenarios where the wall roughness becomes critical, this results in a significant increase in the pressure drop due to the large increase in surface friction.

The data shown in Figure 27 was determined using the best-case scenario when it comes to a tube bundle as AGA-3 has large allowances on the final dimensions and quality of the finished product. It was assumed that the pipes exterior was as smooth as the interior and that no welds were present. It also assumed that there were no blockages in the exterior passages, the holes were fully chamfered on the inlet and outlet and that there was no upstream flange plate. The following changes could significantly affect the resulting pressure drop:

AGA-3 has allowances on the range of the wall thickness of the tubes. This study used a thickness of 2% of pipe ID. AGA-3 allows thickness up to 2.5% to be used. Thicker tube walls would significantly reduce the flowing area, increasing the initial pressure drop in high Reynolds number fluids. The physical welding of the tubes together can increase the friction factor and resultant pressure losses on the exterior of the tubes.

Blocking the inlets of the exterior passages will reduce the overall exterior surface area, but increase the initial entrance losses. AGA-3 states that in pipe sizes of 4” or less, the exterior passages can be sealed. Doing so would reduce the surface

area by about 65% but also reduce the inlet open area to 43.2% of the total pipe area, compared to the open area of 47.7% for the perforated plate. So while the friction losses due to the surface area would be reduced, the initial pressure drop will increase across the entire Reynolds number range.

This study was performed using a tube bundle that has a length twice that of the pipe NPS. AGA-3 states that this applies to tube bundles in pipes larger than NPS 4". AGA-3 states that tube bundles in NPS 2" pipe will have a length of 3 x NPS, which results in a surface area increase of 50%. Tube bundles in pipes greater than NPS 2" and less than/equal to NPS 4" will have a length of 2.5 x NPS, which gives a surface area increase of only 25%.

In a 2" tube bundle, with the exterior outlet passages closed, the open area is 43.2% with a flowing surface area that is still 19 times greater than that of a perforated plate. In a 3" tube bundle, the open area is the same but the flowing surface area is 16 times greater than that of the perforated plate. In these circumstances, the tube bundles will still have a significant amount of pipe wall friction but now they must also deal with much higher entrance losses as well.

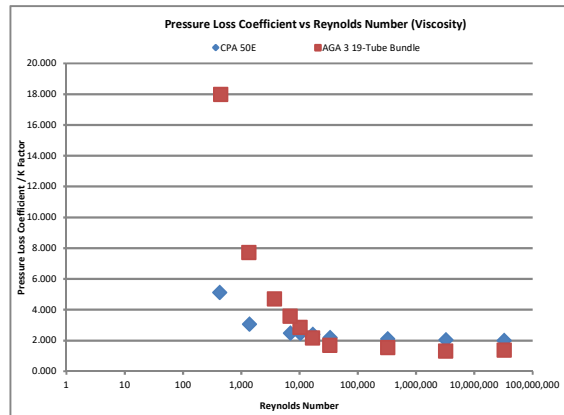

Figure 27: Comparing the pressure drop of an AGA-3 19 Tube Bundle to a perforated plate flow conditioner across a wide range of Reynolds numbers.

## Conclusion

Proper flow conditioning is highly recommended for all measurement systems and especially with differential pressure and ultrasonic flow meters. To ensure that measurement accuracy and repeatability is maximized, a flow conditioner should always be utilized. A properly designed perforated plate flow conditioner was not developed to benefit a particular meter type. Instead, it is designed to improve the fundamental fluid dynamics of the pipe flow itself. The flow conditioner will be designed to create a fully developed flow that is free of swirl, distortions or any other flow asymmetry. The flow conditioners performance is completely independent of the meter that it is installed upstream of.

It is also important to note that a proper flow conditioner is effective in a wide range of fluids and Reynolds numbers. Flow conditioning is not typically fluid specific and perforated plate flow conditioners can be used in many fluids other than just natural gas. It was previously thought that tube bundles should be used in liquid applications due to the lower pressure drop when compared to perforated plate flow conditioners. This was due to performance data that was actually collected from testing in high-pressure natural gas and air. The behaviour of these devices changes significantly as the wall roughness and flow viscosity of the application changes and recent studies have shown that in viscous fluids, tube bundles can have significantly higher-pressure drops than perforated plate flow conditioners.

While orifice meters or other differential devices and ultrasonic flow meters use different techniques for measuring the fluid flow, they have a significant concept in common: they are volumetric devices. Both meters are simply measuring the volumetric state of the pipe flow. They are looking at two significant variables; flow profile quality and swirl. For both metering types, accuracy is directly linked to the quality of the upstream flow. A fully developed flow profile will always maximize meter accuracy as does flow with little to no swirl. Combining a fully developed flow profile with minimal swirl helps guarantee that the meter is in the best possible circumstances for repeatable, accurate measurement. A perforated plate flow conditioner ensures that these are the conditions that the flow meter will always see, effectively cutting it off from all upstream installation effects that would cause unpredictable errors to an unprotected meter. The flow conditioner will eliminate the swirl in the flow and restore the fully developed flow profile, helping the meter ignore the severity of the disturbances upstream. Using a flow meter without proper flow conditioning simply says that we are absolutely sure there is an extremely long distance of straight pipe upstream of the meter or that our flow measurement is simply good enough and we don't wish for it to be any more accurate.

## References

Y. Cengel. J. Cimbala. "Flow In Pipes" in Fluid Mechanics: Fundamentals and Applications, 1st Edition. New York, NY: McGraw-Hill, 2006, pp. 321-386

F. White. "Viscous Flow In Ducts" in Fluid Mechanics, 5th Edition. New York, NY: McGraw-Hill, 2003, pp. 343-426

"Part 2: Specification and Installation Requirements" in AGA Report No. 3, 4th Edition, 2nd Printing. Washington, DC: American Gas Association, 2003, pp 16-17.

ISO 5167-1:2002, "General Principles and Requirements"