

FUNDAMENTALS OF VOLUME MEASUREMENT (TURBINE METERS)

Tony Petitto

FMC Technologies Measurement Solutions, Inc.

INTRODUCTION

Turbine meters have been used for the custody transfer of refined petroleum products and light crude oils for over 40 years. When correctly applied, they offer high accuracy and long service life over a wide range of products and operating conditions. Traditionally turbine meters were used for the measurement of low viscosity liquids and PD meters for higher viscosities. However, new developments in turbine meter technology are pushing these application limits while increasing reliability and accuracy. This paper will examine the fundamental principles of turbine meter measurement as well as new developments including: smart preamps for real-time diagnostics, helical flow turbine meters for higher viscosity applications, higher performance flow conditioners to increase accuracy, and viscosity compensation to extend the application limits.

HISTORY

With the development of jet engines and liquid propellant rockets in the 1950's, the need arose for an accurate, quick response meter that could be used on exotic fuels and oxidizers at extreme temperatures. The turbine meter met this need. It was soon applied to many other industrial flow measuring applications.

Turbine meters began to be applied extensively in the petroleum industry in the mid-1960's. Since publication of API Standard 2534 "Measurement of Liquid Hydrocarbon by Turbine Meter Systems" in March, 1970, the turbine meter has gained broad acceptance for custody transfer of petroleum liquids such as liquefied petroleum gases (LPG's), light distillates, and light crude oils, primarily at large petroleum storage and transfer terminals.

TYPES OF METERS

Fluid flow meters can, in general, be classified as either positive displacement or inference type meters. Positive displacement (PD) meters measure volumetric flow *directly* by continuously separating (isolating) a flow stream into discrete volumetric segments and counting them. Inference meters *infer* volumetric flow rate by measuring some dynamic property of the flow stream. Turbine meters fall in the latter category.

The most common examples of inference meters are orifice plates, Coriolis mass meters, vortex shedding meters, ultrasonic meters, and of course turbine meters.

BASIC ASSUMPTIONS

Turbine meters infer flow rate from the measurement of rotational movement (angular velocity) of a bladed rotor or impellor suspended in the flow stream. Thus, two levels of inference (basic assumptions) are necessary to obtain volumetric flow rate from a turbine meter.

First Assumption

Volumetric Flow Rate \propto Avg. Stream Velocity

Second Assumption

Avg. Stream Velocity \propto Rotor Angular Velocity

The degree to which these two basic assumptions are correct determines the accuracy of the turbine meter.

CONSTRUCTION

There are three basic sub-assemblies in a conventional turbine meter (see Figure 1):

1. Meter Housing
2. Internal Assembly
 - a) Open Bladed Rotor (1A)
 - b) Rimmed Rotor (1B)
3. Pulse Pickup Assembly

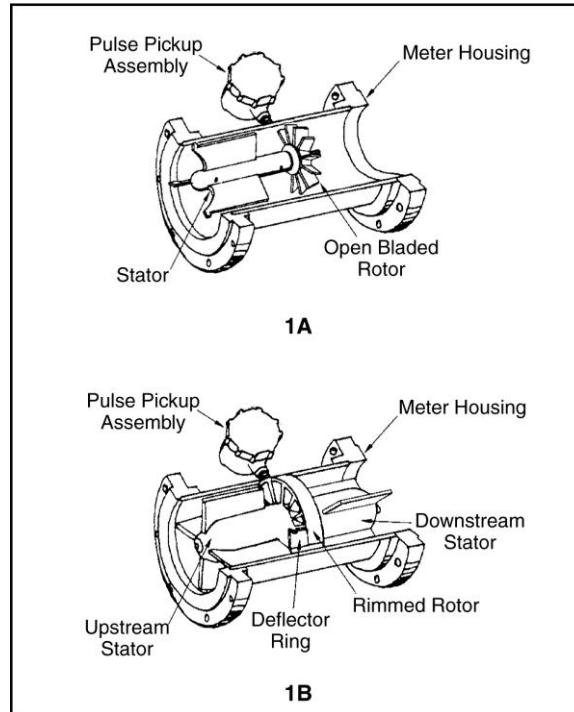

Figure 1. Turbine Meter Cross-Sectional

METER HOUSING

The meter housing sub-assembly is normally constructed of a flanged pipe spool in sizes ranging from 1/4" to 24", with virtually any type of end connection and pressure rating.

Materials are selected to be compatible with the product being measured. Typically, only the pipe spool comes in contact with the fluid. Therefore, the flanges (being non-wetted) generally need not be compatible with the fluid. Thus, carbon steel flanges are normally used, with an alternative such as stainless steel, being available for corrosive atmospheres.

A deflector ring of the same material as the housing is used with a rimmed rotor to prevent the flow stream from impacting on the rotor rim and to provide a smooth flow transition into the rotor area.

To obtain reliable signal generation, it is essential that the material in the immediate vicinity of the pickup coil be non-magnetic. However, a small ferromagnetic plug directly beneath the pickup coil tip is required to focus the magnetic flux field generated by the pickup coil.

When a second pickup coil is used, it is located so the signal is approximately 90 degrees out of phase with the initial pickup coil. This allows the following features to be added to the remote electronic instrument(s): (1) frequency doubling for greater proving resolution; (2) automatic direction sensing for bi-directional turbine meters; (3) signal comparison for signal transmission security, and (4) a second pulse output for proving purposes.

INTERNAL PARTS SUB-ASSEMBLY

The only moving part in a turbine meter is the rotor, which is free to rotate on a bearing, mounted on a shaft that is suspended in the flow stream by a stator. Traditionally, rotors are a series of blades that are fixed to a hub at a specific angle, causing rotation when in the fluid stream. Rotors may be open type, which is typical in smaller meters with line sizes of less than six (6) inches. The blades of these rotors are normally constructed of 400 stainless steel or another ferromagnetic material that can be detected by a reluctance type pick-up coil. For larger meters, a rimmed rotor is used to add rigidity to the blades and increase the pulse resolution by adding more detection points per rotor revolution.

There are a variety of bearing types and materials, but hard-surfaced journal bearings have been proven the most suitable for petroleum applications. The bearings are highly polished to reduce frictional drag and are lubricated by the fluid media. Hard-surfaced thrust washers are also required with these designs to limit rotor endplay. In many journal bearing designs, however, a floating rotor is utilized so that the rotor bearing only contacts a thrust washer during start-up, changes in flow, or if the meter is operating outside the meter's normal flow range. Good bearing design is not only important for long service life, but also for repeatability and accuracy.

Stator designs are of two types; one supports the rotor at both ends and the other is a cantilever design that supports only the upstream end. The cantilever-type support is sufficient for light weight rotor assemblies used in small size meters whereas dual supports are required for larger meters.

PULSE PICKUP ASSEMBLY

The detector sub-assembly normally consists of a reluctance type pickup coil, explosion-proof junction box, and typically a preamplifier. The pickup coil is threaded into the pickup coil "boss" that has been welded to the housing in a location directly in line with the rotor. Signal transmission wires are connected to the pickup coil inside the explosion-proof junction box, which is normally threaded to the outside of the pickup coil "boss". Usually there are provisions in the junction box for mounting an optional preamplifier.

A typical reluctance-type pickup coil has an outer case of stainless steel, threaded at the bottom for mounting on the meter. At the bottom, the threaded end of a ferromagnetic pole piece (tip) projects out to help focus the magnetic field onto the path of the ferromagnetic material (blades or rim buttons) on the rotor periphery. The tip does *not* penetrate the housing wall. The air gap, or distance between coil tip and rotor rim or blades, varies from approximately 1/16" to 5/16" depending on meter size. A two-pin connector mounts on top for signal connections to the transmission line.

The main internal parts of a reluctance-type pickup coil are the coil bobbin and permanent magnet. The coil bobbin consists of many thousand turns of fine wire wrapped around a ferromagnetic core. This core is simply an extension of the pole piece (tip) previously mentioned. On top of the coil bobbin is a permanent magnet. It is magnetized North-South longitudinally along the main coil axis. The coil wire is brought up to the connector in protecting sleeves. The entire assembly is potted for thermal and mechanical protection.

SIGNAL GENERATION

Signals are generated by the rate of change of magnetic flux passing through the coil bobbin. The output voltage is proportional to the number of turns of coil wire and the rate of change of magnetic flux in the coil bobbin. Peak- to-peak voltage is thus proportional to rotor speed.

In Figure 2A, the approaching ferromagnetic blade or button creates an increase in the magnetic flux in the coil. As the flux changes from a low level to a higher level, the changing flux generates a positive portion of the output signal. Amplitude is proportional to the number of turns of wire and how fast the flux level changes.

In Figure 2B, the ferromagnetic material in the rotor periphery is directly opposite of the coil. The rate of change of flux is zero since the coil bobbin has reached its highest level of flux density. The voltage drops to zero.

In Figure 2C, the ferromagnetic material is leaving the field of the coil, reducing the flux density from maximum to minimum. This causes a rate of change of flux in the opposite direction, generating the negative portion of the output signal.

Finally, in Figure 2D, the ferromagnetic material has left the pickup coil's field of influence. Both the rate of change of flux and the output signal are reduced to zero.

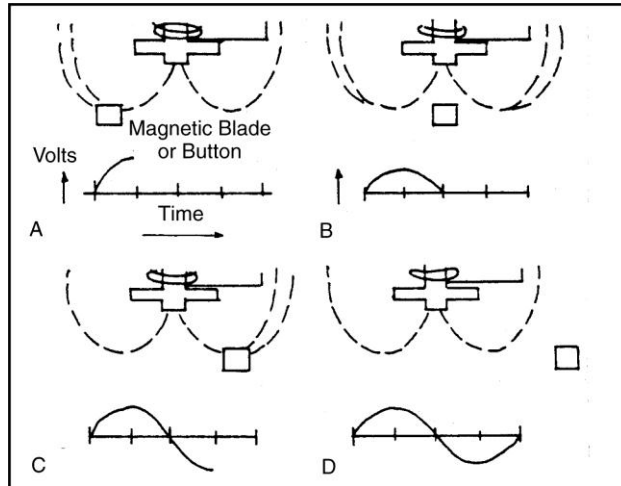

Figure 2. Principle of Reluctance Signal Generation

SIGNAL AMPLIFICATION AND TRANSMISSION

The signal generated by the pickup coil is typically in the mV range and it would be too weak for long transmission or susceptible to electrical noise. For this reason this low level signal is fed into a preamplifier, whose function is to convert a small mV sinusoidal signal into a 12V or 24V square wave (see Figure 3). The square wave output can be sent to distances up to 6,000 ft. The number of pulses that are generated per unit volume by a turbine meter (or any type of meter for that matter) is defined as the nominal K-factor. Examples of nominal K-factors are 1,050 pulses per barrel or 50 pulses per gallon

VOLUME CALCULATIONS

Pulses generated by the turbine meter are sent to a totalizer or flow computer (either can be local or remote) and converted to volume. The totalizer or flow computer is programmed with the meter’s nominal K-factor and it counts the number of pulses received from the turbine meter. The Indicated Volume (IV) is then calculated by dividing the number of pulses received by the nominal K- factor:

$$IV = \# \text{ pulses} / K\text{-factor} \quad \text{(Equation 1)}$$

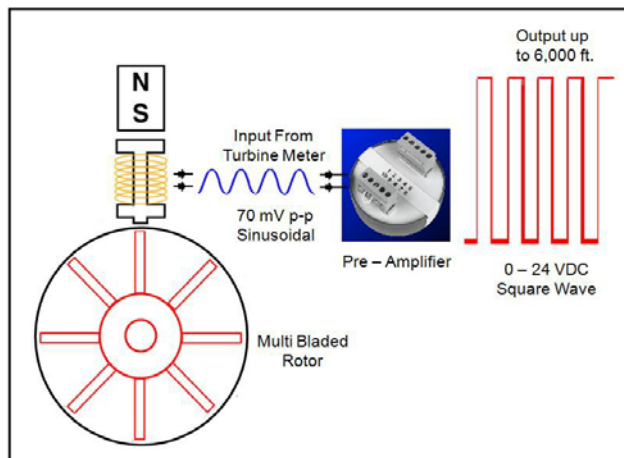

Figure 3. Pickup Coil Signal Amplification

The Indicated Volume needs to be adjusted by a Meter Factor (MF) to correct for turbine meter accuracy changes due to changes in product characteristics (primarily viscosity), changes in process conditions (primarily flow) and installation / wear effects. The Meter Factor is calculated by dividing the Volume indicated by a standard reference by the Indicated Volume of the Meter. Typical standard references are Certified Volumetric Tank Provers, Displacement Provers or Master Meters. The procedure to determine a Meter Factor is called Meter Proving and for best accuracy results it shall be

performed under the actual meter operating conditions. During meter proving, several consecutive proving runs that fall within specified repeatability criteria are averaged out and the resulting Meter Factor is then used for that particular meter, that particular product, and those particular operating conditions (flow rate, pressure and temperature).

$$MF = \text{Reference Volume} / IV \quad (\text{Equation 2})$$

On the other hand, transactions involving the transfer of liquid hydrocarbons may occur at different operating conditions, and as such they need to be normalized to a set of standard conditions. Typically these standard conditions are 60 F for Temperature and 0 psig (atmospheric) for pressure. For liquefied gases or volatile liquids, the base pressure used is the Equilibrium Vapor Pressure. The Indicated Volume at actual operating conditions is adjusted by CTL which corrects for the effect of temperature on the liquid volume and by CPL which corrects for the effect of pressure on the liquid volume. CTL which is related to the fluid's thermal coefficient of expansion, and CPL which is related to the fluid's compressibility, can be obtained by formulas or from tables that are issued by the American Petroleum Institute (API) or the Gas Processors Association (GPA).

The Gross Standard Volume (GSV) is then obtained by multiplying the Indicated Volume (IV) by CTL, by CPL, and by the Meter Factor (MF):

$$GSV = IV \times (CTL \times CPL \times MF) \quad (\text{Equation 3})$$

Sometimes, the three correction factors are multiplied by each other and the result is also known as the Combined Correction Factor (CCF). Based on this combination, the GSV equation can be rewritten as:

$$GSV = IV \times CCF \quad (\text{Equation 4})$$

For crude oils, an additional factor to correct for Sediment and Water (CSW) is also applied to determine the Net Standard Volume (NSV):

$$\begin{aligned} NSV &= [IV \times (CTL \times CPL \times MF)] \times CSW \\ \text{or} \\ NSV &= GSV \times CSW \end{aligned} \quad (\text{Equation 5})$$

Where:

$$CSW = 1 - (\% \text{ S\&W} / 100) \quad (\text{Equation 6})$$

For example a 1% S&W relates to a CSW = 0.99. For clean and processed products that have no S&W, CSW is equal to 1.

TURBINE METER PERFORMANCE

The performance characteristics (see Figure 4) essential for the proper application of a turbine meter are:

- Repeatability – the meter's ability to reproduce the same measurement (same Meter Factor) for a set of constant conditions of flow rate, temperature, viscosity, density and pressure.
- Linearity – the meter's ability to maintain a nearly constant Meter Factor through-out the stated flow range.
- Flow Range – the range over which the meter can accurately measure.
- Accuracy – the difference from the actual measurement and the meter's indicated measurement. Typically meter accuracy is stated in terms of Meter Factor
- Stability – the ability for a meter to maintain its Meter Factor over time at the same operating conditions.

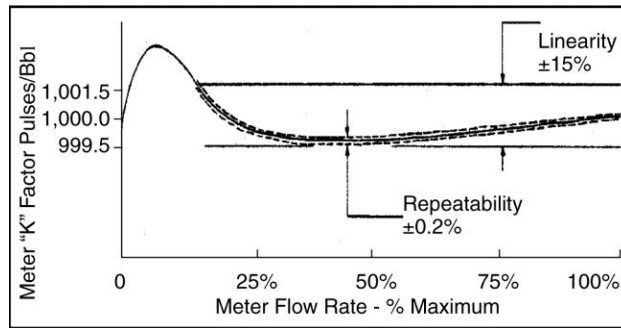

Figure 4. Typical Performance Curve

FACTORS AFFECTING METER ACCURACY

Exceptionally high accuracy can be obtained from high quality turbine meters under proper operating conditions. However, it is important to understand how certain operational factors can significantly degrade turbine meter performance. The various factors that can reduce meter accuracy actually do so by affecting the validity of one or both of the two previously mentioned basic assumptions required to obtain volumetric flow rate from a turbine meter.

CONSTANT FLOW AREA ASSUMPTION

The first basic assumption that volumetric flow rate is proportional to average fluid velocity is based on the following fundamental relationship:

$$\text{Volume Flow Rate (Q)} = \text{Velocity (V)} \times \text{Area (A)} \quad (\text{Equation 7})$$

This first basic assumption is correct if the effective flow cross-sectional *area* remains *constant*. The effective rotor flow area, and thus meter "K" factor, can change for any one or a combination of the following reasons:

1. Erosion - from abrasive contaminants (sand).
2. Corrosion - from corrosive contaminants (acid).
3. Deposits - from solids precipitating out (wax).
4. Boundary Layer Thickening - from high viscosity or lower flow.
5. Cavitation - from low back pressure.
6. Obstructions - from trash, "grass", upstream buildup, etc.

Erosion, Corrosion, Deposits

Even a seemingly small buildup or erosion of the bladed rotor between meter provings can have a significant effect on meter performance. For example, a one mil (0.001") buildup on all surfaces of a 4" rotor will decrease the flow area through the rotor, and thus the meter factor, by about 0.5%.

Boundary Layer Thickness

Boundary layer thickness is relatively constant and insignificant when operating in the turbulent flow region, Reynold's Number, $Re > 10,000$. However, boundary layer thickness increases significantly in the laminar flow region ($Re < 2,000$).

$$*Re = [2214 \times \text{Flow Rate (BPH)}] / [\text{Diameter (inches)} \times \text{Viscosity (cSt)}] \quad (\text{Equation 8})$$

The Universal Turbine Meter Performance Curve (K- factor versus Re) shown in Figure 5 illustrates the effect of boundary layer thickening on meter performance.

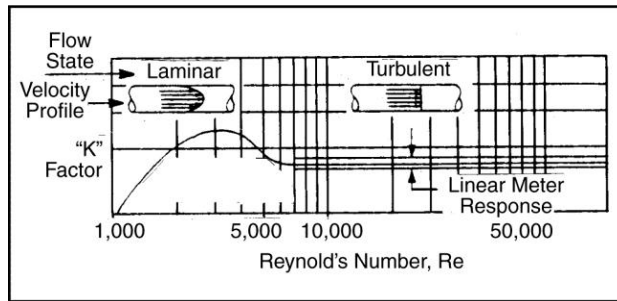

Figure 5. Universal Turbine Meter Performance Curve

Table 1 shows the Reynolds Numbers for a 6” turbine meter at minimum / maximum flow rate and viscosity from 1 cSt to 500 cSt.

Viscosity cSt	Reynolds Number @ Min / Max Flow (BPH)	
	4,000	400
1	1,474,000	147,400
5	294,800	29,480
50	29,480	2,948
100	14,740	1,474
500	2,948	295

Table 1. Reynolds Number at Various Viscosities

Cavitation

Cavitation (the local vaporization of product) substantially reduces flow area through the rotor, thereby dramatically increasing fluid velocity through the rotor, and meter K-factor, as shown in Figure 6. Cavitation is eliminated by increasing system back pressure on the meter. API recommends:

$$BP = 2 \times \Delta P + 1.25 \times VP \tag{Equation 9}$$

Where:

- BP = Minimum pressure at the meter.
- ΔP = Pressure drop at maximum flow rate.
- VP = Vapor pressure of the liquid.

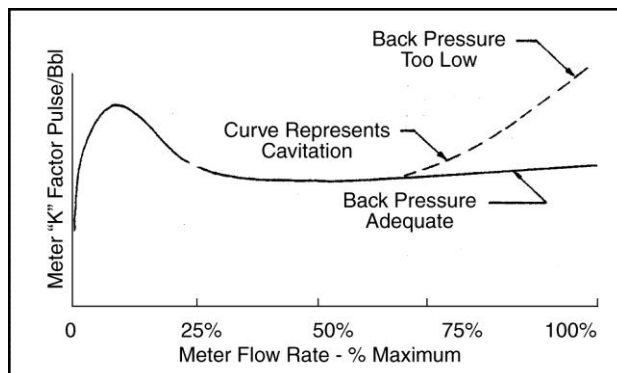

Figure 6. TM Performance with Cavitation

Obstructions

Temporary obstruction, such as trash or “grass” immediately upstream of the bladed rotor can substantially decrease effective flow area through the rotor, as well as cause a pronounced shift in fluid velocity profile.

CONSTANT ROTOR/FLUID VELOCITY RATIO ASSUMPTION

The second basic assumption is that the average fluid velocity is directly proportional to the measured rotor angular velocity. This assumed constant rotor / fluid velocity can be affected by:

1. Rotor Blade Angle
2. Rotor Stability
3. Velocity Profile and Swirl
4. Rotor Bearing Friction
5. Viscous Drag
6. Fluid Density

Rotor Blade Angle

The angle of the rotor blade can change if it is struck by a foreign object. Also, a blade designed with poor rigidity characteristics can flex to a different angle for different blade loading conditions.

Rotor Stability

The major factors affecting rotor stability are rotor balance and rotor/shaft bearing fit. Good rotor balance is crucial to good meter performance. Rotors can be unbalanced by uneven deposits or erosion. Bearing fit is also affected by deposits and wear. The effect of increased rotor instability is primarily increased rotor drag (mechanical friction at bearing).

Velocity Profile and Swirl

Variations in velocity profile or fluid swirl are common causes of measurement errors that can be minimized by proper installation. Figure 7 depicts both an ideal symmetrical velocity profile and a distorted profile, which changes the proportion between rotor velocity and fluid velocity. Figure 8 depicts the effect of swirl, which can erroneously increase or decrease the average stream velocity. Both conditions become more pronounced when multiple meters are feed from a common header; meters are operated over wide flow range; and lighter viscosity fluids are metered. To minimize flow distortion, API Standard 2534 recommends the use of upstream and downstream flow conditioners as shown in Figure 9. New flow conditioners have been recently introduced which can further reduce flow distortion over a wider range of operating conditions.

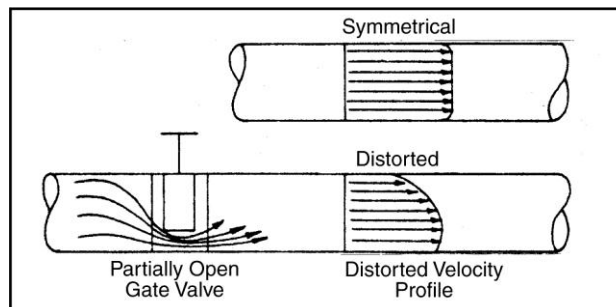

Figure 7. Velocity Profile Distortion After Gate Valve

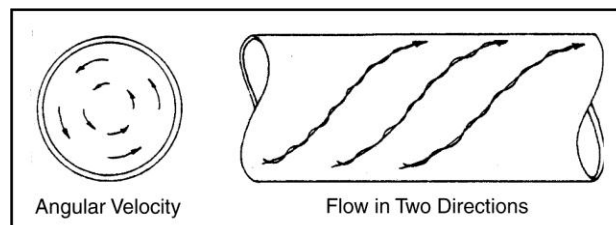

Figure 8. Effect of Fluid “Swirl”

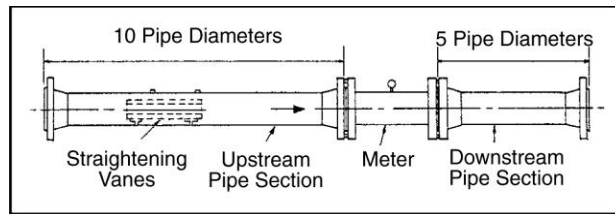

Figure 9. API Recommended Flow Conditioning

Rotor Bearing Friction

The friction factor between the rotor and platform bearings is determined by the finish of the bearing surfaces and the fluid lubricity in the clearance between them. The hard surfaced journal bearings normally used in high accuracy turbine meters have a 2-3 micron mirror-like surface finish. The clearance dimension between bearings is tightly controlled to ensure there is a liquid film on which the rotor rides. Bearing friction can increase substantially if extremely fine particles become lodged in the bearing clearance.

In some turbine meter designs, rotor *thrust* bearing friction is eliminated by hydraulically balancing the rotor over its normal flow range. This is done by using a technique similar to that shown in Figure 10.

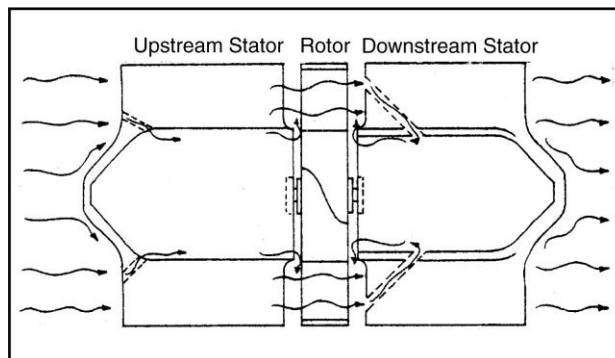

Figure 10. Floating Rotor – Smith Meter Sentry Series Turbine Meter

Viscous Drag on Rotor

The viscous drag on the rotor is related to the fluid viscosity, the distance between the rotor blade tips (or rim) and housing, and the surface finishes in this area. Erosion, corrosion and deposits in this area can have a significant effect on a meter's performance.

Fluid Density

The rotor driving torque available to overcome rotor drag forces is directly proportional to the fluid density and fluid velocity squared. Therefore as the fluid density decreases - as with gasoline or LPG products - the driving torque decreases, resulting in a decrease in performance at lower flow rates. To maintain the proper driving torque for fluids whose Specific Gravity is less than 0.8, the minimum flow rate must be increased by:

$$\text{Rate Increasing Factor} = 0.9 / \text{SG} \quad (\text{Equation 10})$$

Where:

SG = The specific gravity of the product being metered

The maximum flow can also be increased using the above equation but it cannot exceed the maximum specified rating of the meter.

NEW DEVELOPMENTS IN TURBINE METERS

Smart Preamplifiers

The Smart Preamplifier is a dual-purpose device which provides traditional signal conditioning and real-time performance diagnostics. The device uses a high-speed microprocessor to continuously monitor and analyze the rotation of the turbine meter rotor. A high-speed (2 MHz) clock is utilized to capture data on the characteristics of the signal generated between each blade. Initially, the meter is proven and the data collected at this time is stored to provide a signature signal profile defined as “perfect” for accurate measurement. The output signal is continually monitored against this “perfect” signature. Then utilizing sophisticated algorithms, measurement problems can be identified. The Smart Preamplifier can detect a bent blade, a bad bearing, bearing wear, debris on the rotor and cavitation.

Multi-Viscosity Turbine Meters

Multi-viscosity meters with helical rotors can accurately measure over a wider range of viscosities. Their unique rotor design also minimizes the effect of wax or other deposits on performance. Figure 11 shows the typical application ranges for conventional turbine meters, multi-viscosity turbine meters and PD meters.

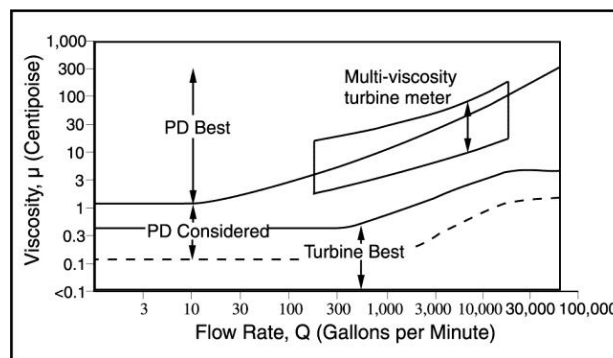

Figure 11. Meter Application Ranges

High Performance Flow Conditioners

Maintaining uniform flow profile is critical to achieving precise turbine meter measurement. A conventional flow conditioner (that is a pipe spool with tube bundle) adequately eliminates rotational flow, but has only a limited affect in reducing flow distortion. The new high performance-type conditioners (a fin type shown in Figure 11) virtually eliminates both flow distortion and rotation over a wide range of viscosities and flow rates.

Viscosity Compensation

Two fluid parameters, velocity (flow rate) and viscosity, highly affect turbine meter performance. By plotting flow rate / viscosity vs K-factor we can define the meter’s performance over a wide range of fluids and flow ranges. This universal performance curve can be defined mathematically and programmed into a meter mounted or other type of processor. When flow rate, which is a direct output of the meter, and viscosity information are supplied to the processor, the output can be corrected for inaccuracies caused by changes in either parameter. Figures 12 and 13 show meter performance with and without compensation.

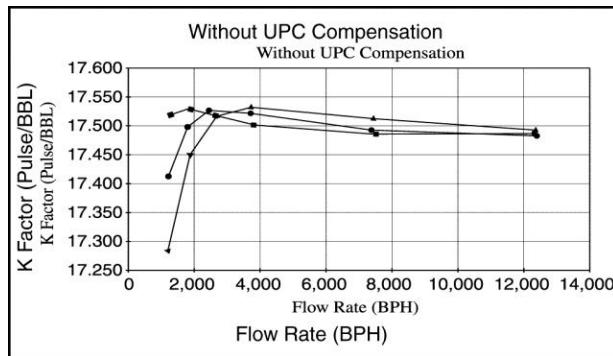

Figure 12. Meter Performance with Compensation

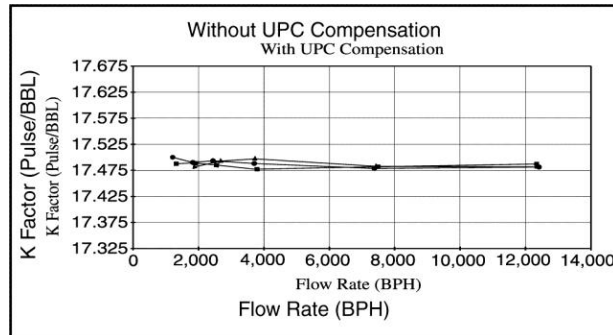

Figure 13. Meter Performance without Compensation

CONCLUSION

Turbine meters can provide highly accurate flow measurement over a wide range of fluids and operating conditions if properly applied, installed and operated. With new developments in turbine meters, accessories and processors, the scope of applications is even further expanded.

REFERENCE

This technical paper is a revision of TP02001/TP103A, Issue/Rev. 0.0 (5/88), originally presented by Philip D. Baker and Raymond J. Kalivoda at I.S.H.M. in April, 1977.